

# X-Rack

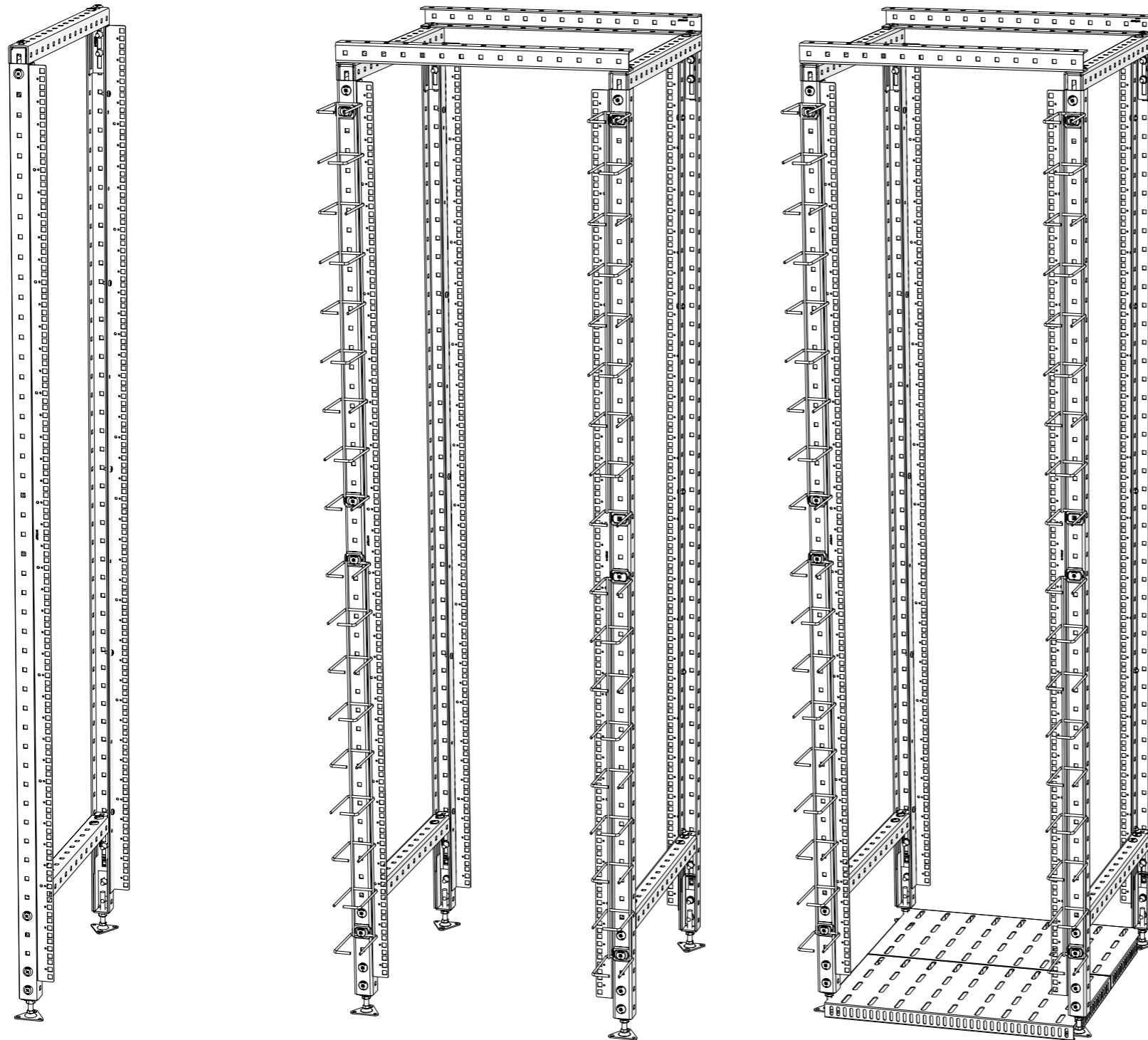

**AXELENT WIRE TRAY**  
[WWW.AXELENTWIRETRAY.COM](http://WWW.AXELENTWIRETRAY.COM)

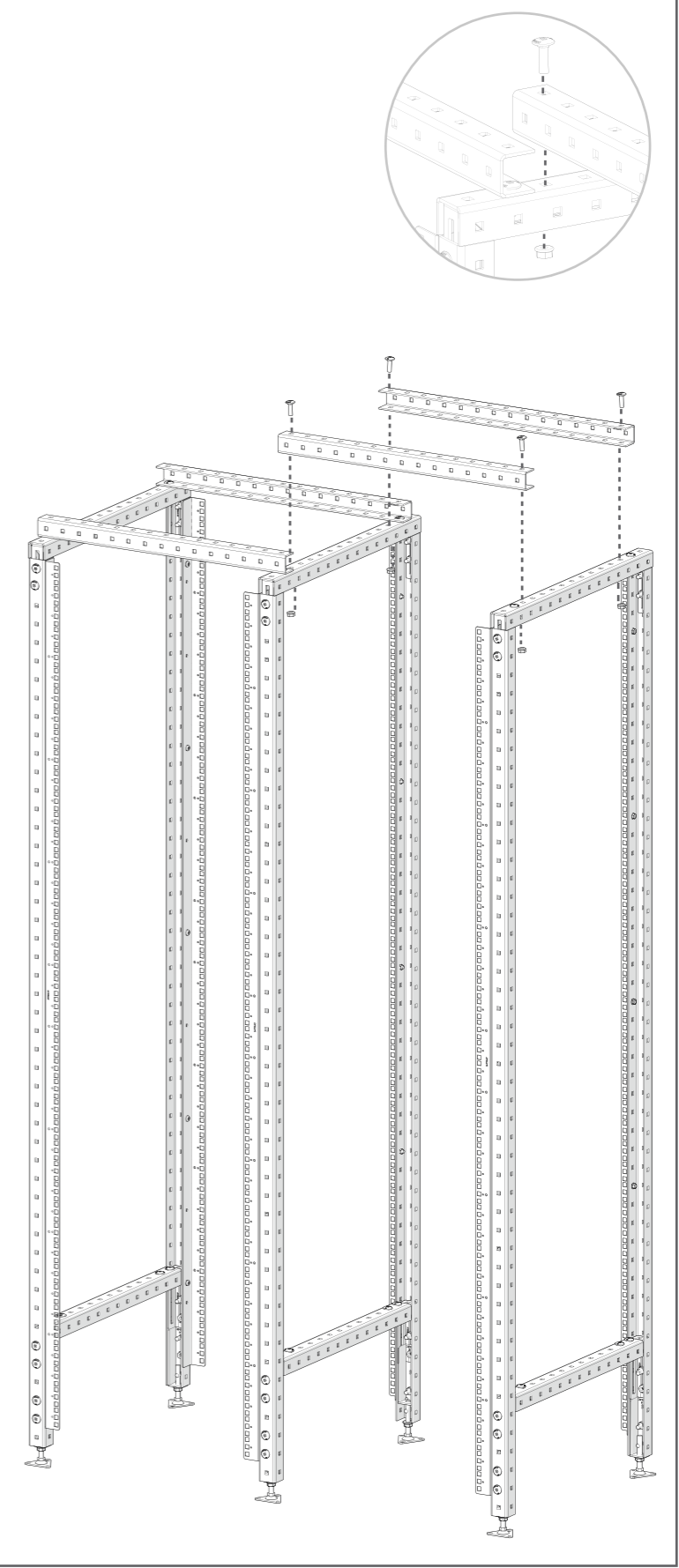

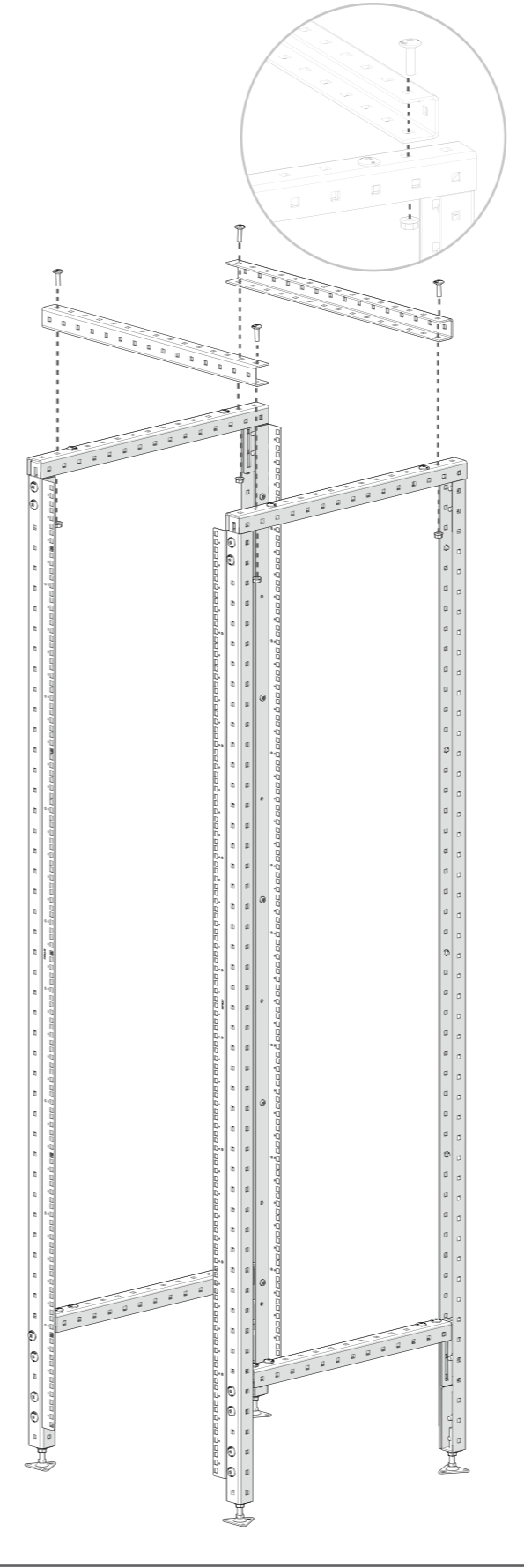
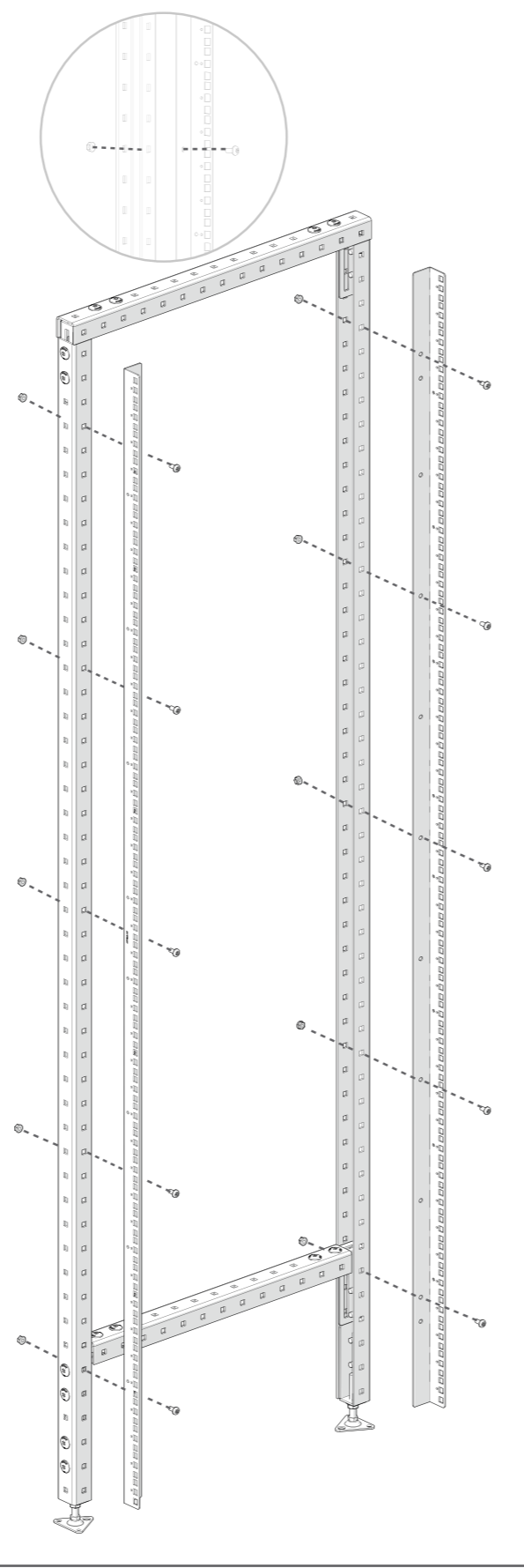
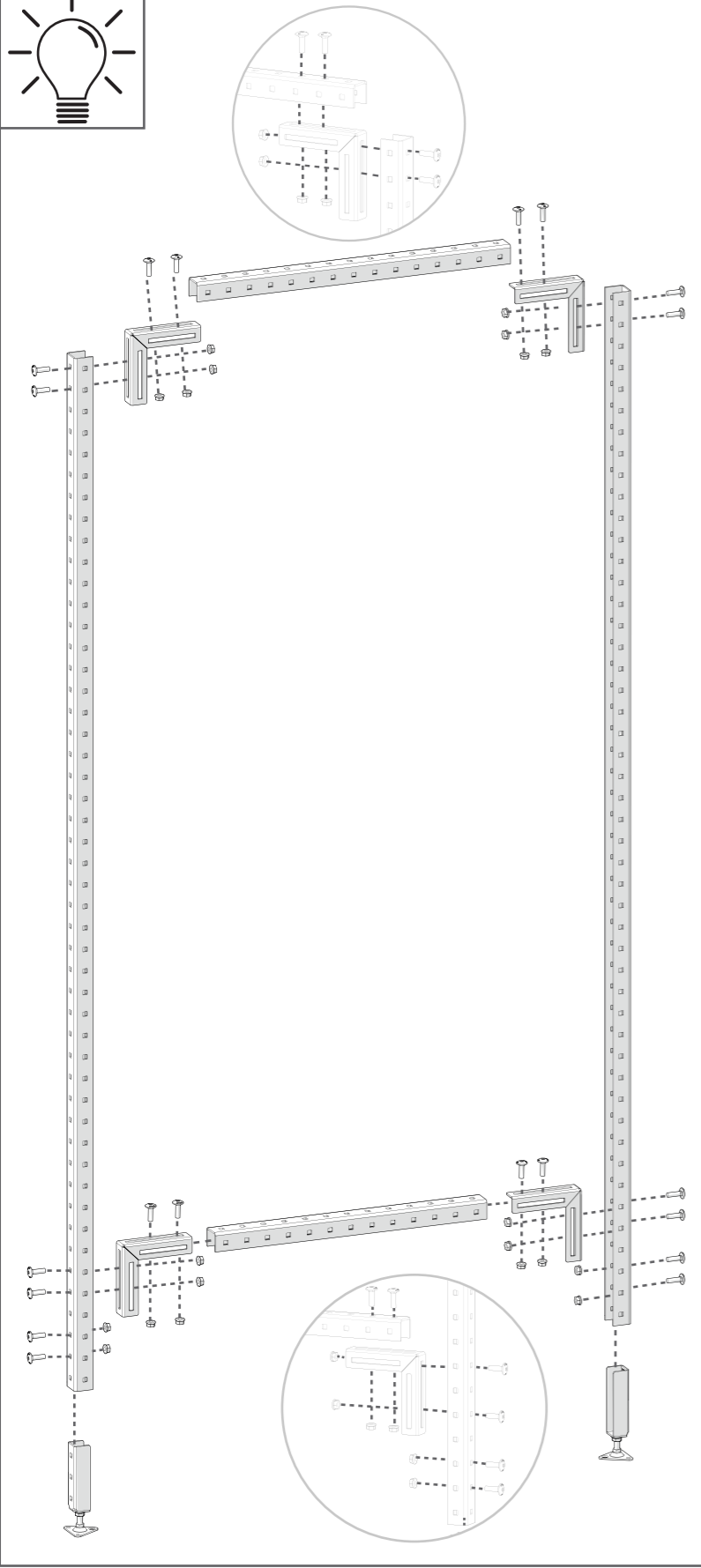

**7100-215**  
E: 5001085

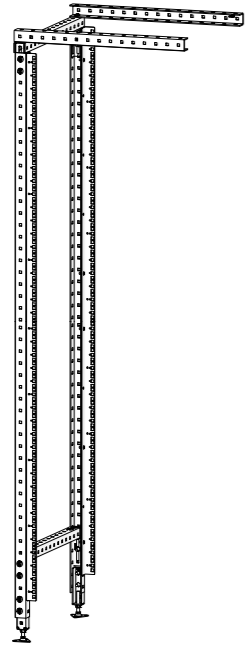

**7100-216**  
E: 5001086

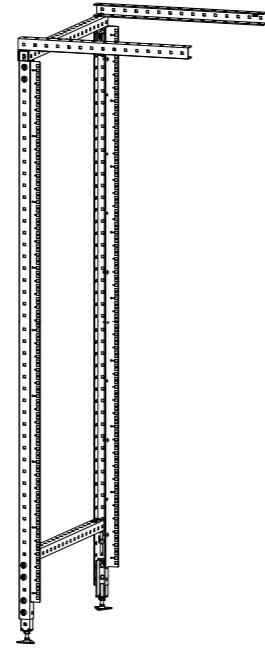

**7100-217**  
E: 5001087

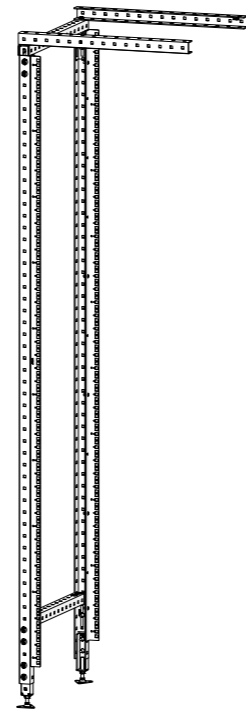

**7100-218**  
E: 5001088

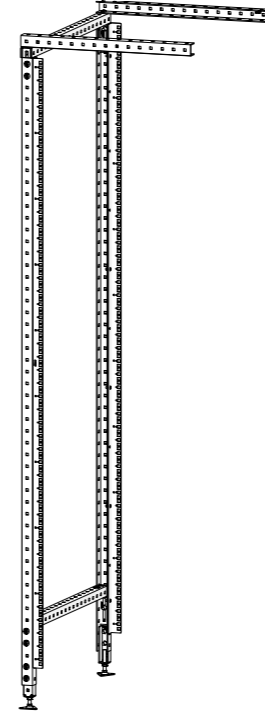

**7100-219**  
E: 5001102

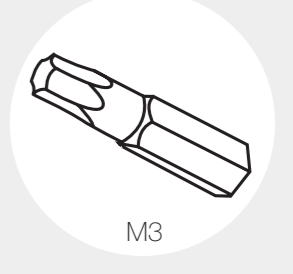
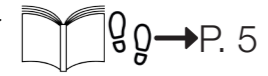
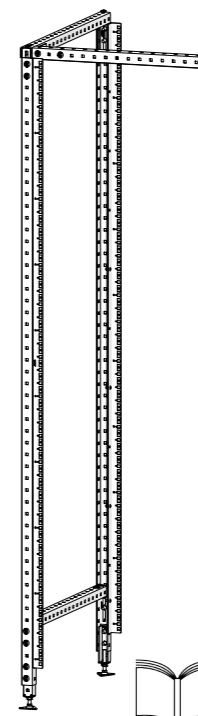

**7100-215/216/217/218**  
E: 5001085/  
5001086/  
5001087/  
5001088

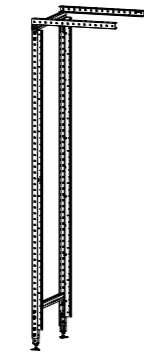

Parts

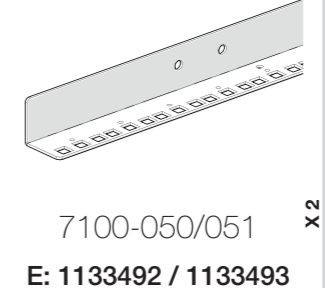
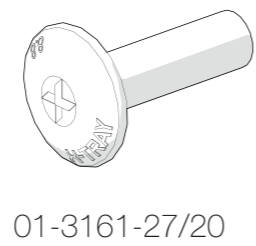
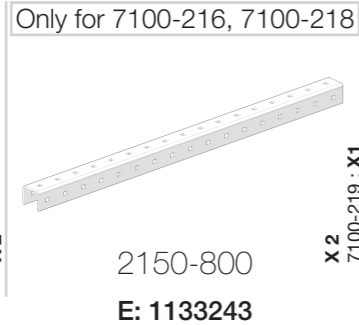
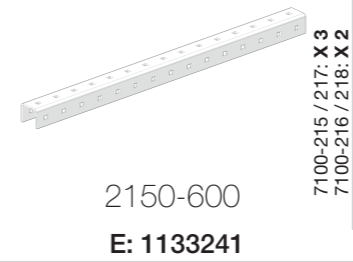
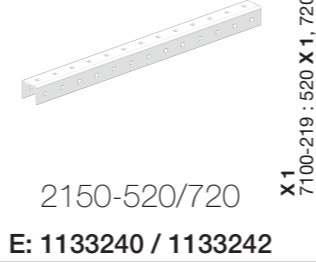
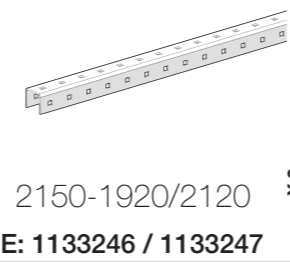

**7100-052/250-2**  
E: 5001089/  
5001090

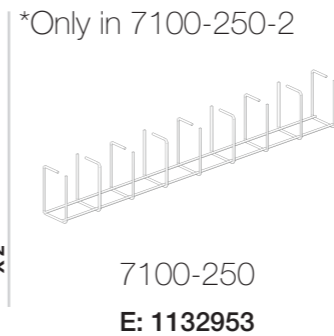
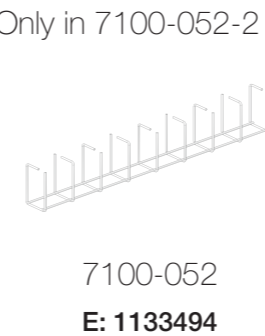

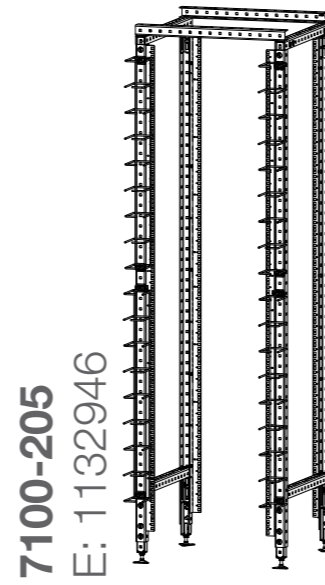
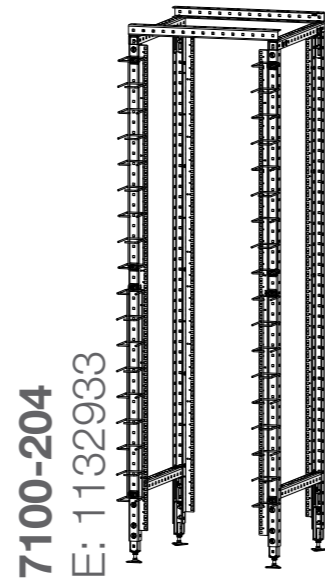
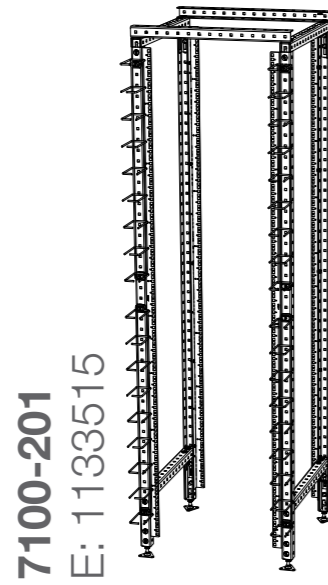
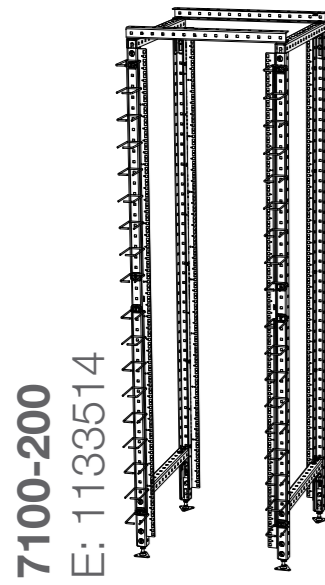

<b>7100-200/201/204/205</b> E: 1133514/ 1133515/ 1132933/ 1132646		2150-1920/2120 E: 1133246 / 1133247	X4		2150-520 E: 1133240	X2		2150-600 E: 1133241	X4		2152 E: 1133251	X8		2153 E: 1133252	X4
---	--	--	----	--	------------------------	----	--	------------------------	----	--	--------------------	----	--	--------------------	----

	2161 E: 1133257	X44		2162 E: 1133258	X44		7100-056 E: 1133497	X20		7100-057 E: 1133498	X20		7100-050/051 E: 1133492 / 1133493	X4
--	--------------------	-----	--	--------------------	-----	--	------------------------	-----	--	------------------------	-----	--	--------------------------------------	----

<b>7100-052/250</b> E: 1133494/ 1132952 x 4		2161 E: 1133257	X2		2162 E: 1133258	X2		2101 E: 1133211	X2		01-7100-052 *Only in 7100-052	X1		01-7100-250 *Only in 7100-250	X1
--	--	--------------------	----	--	--------------------	----	--	--------------------	----	--	----------------------------------	----	--	----------------------------------	----





1

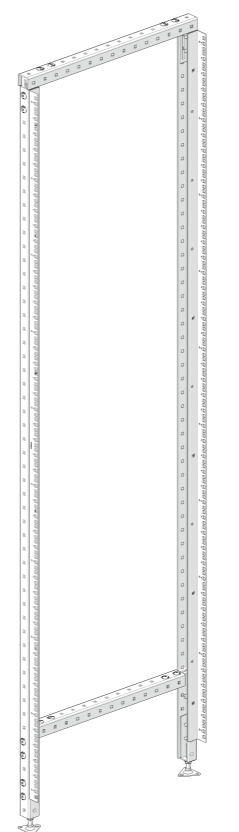
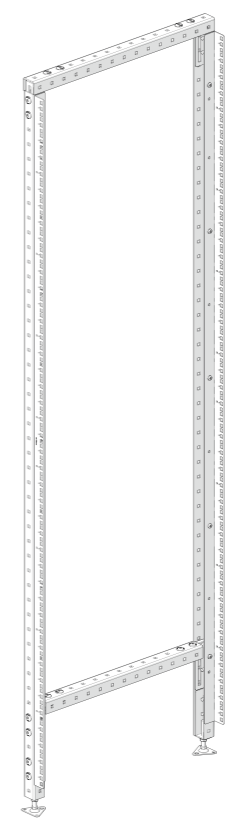
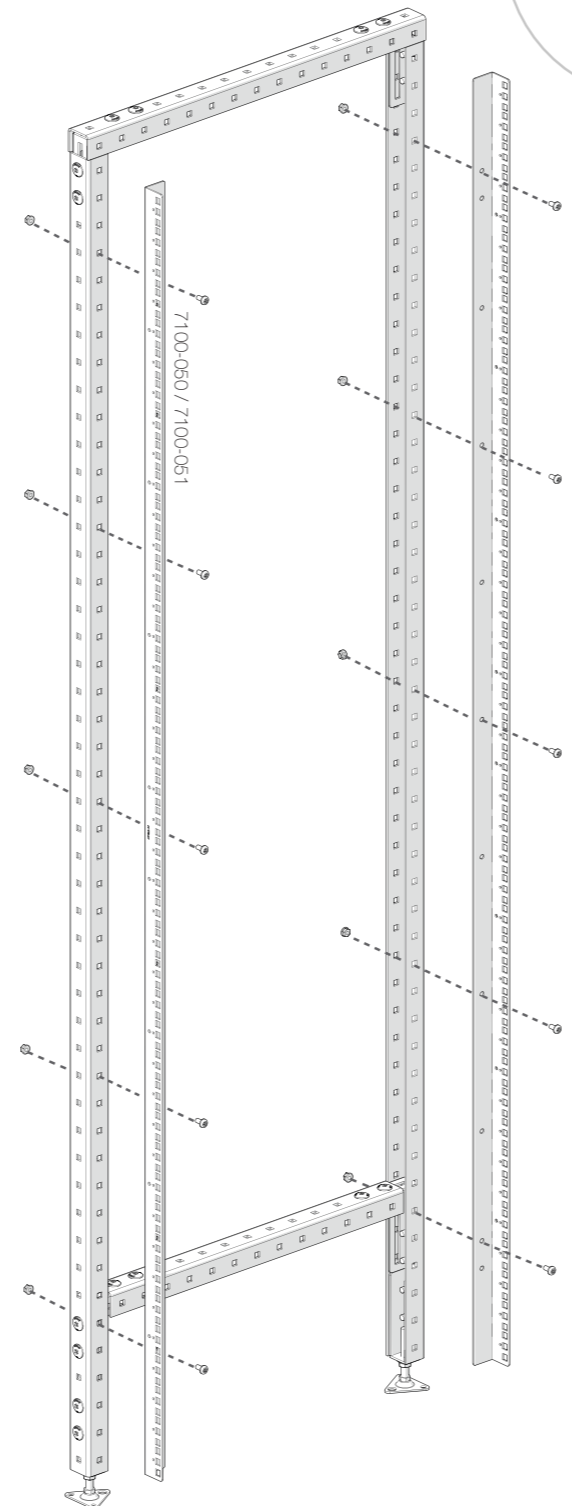
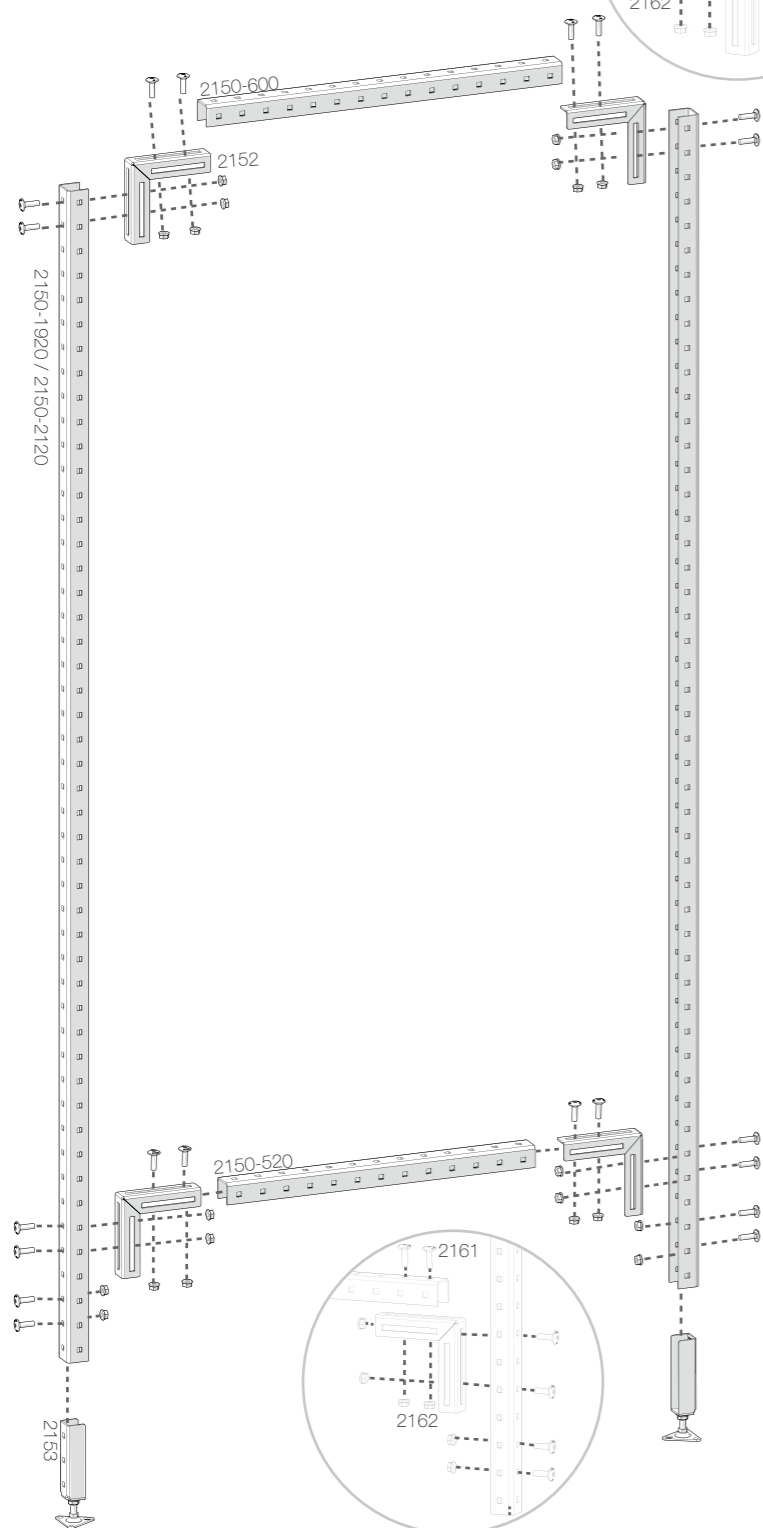
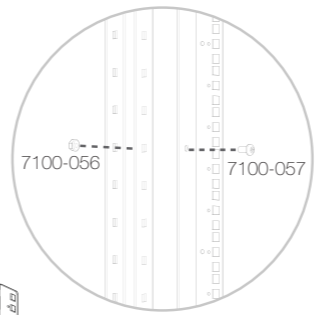
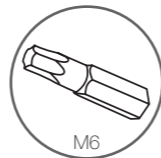
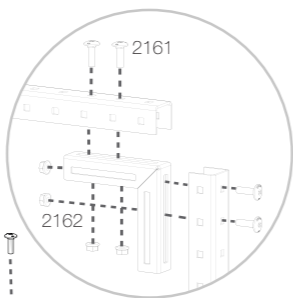

2

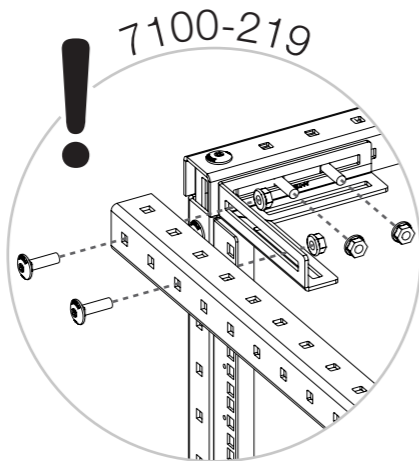
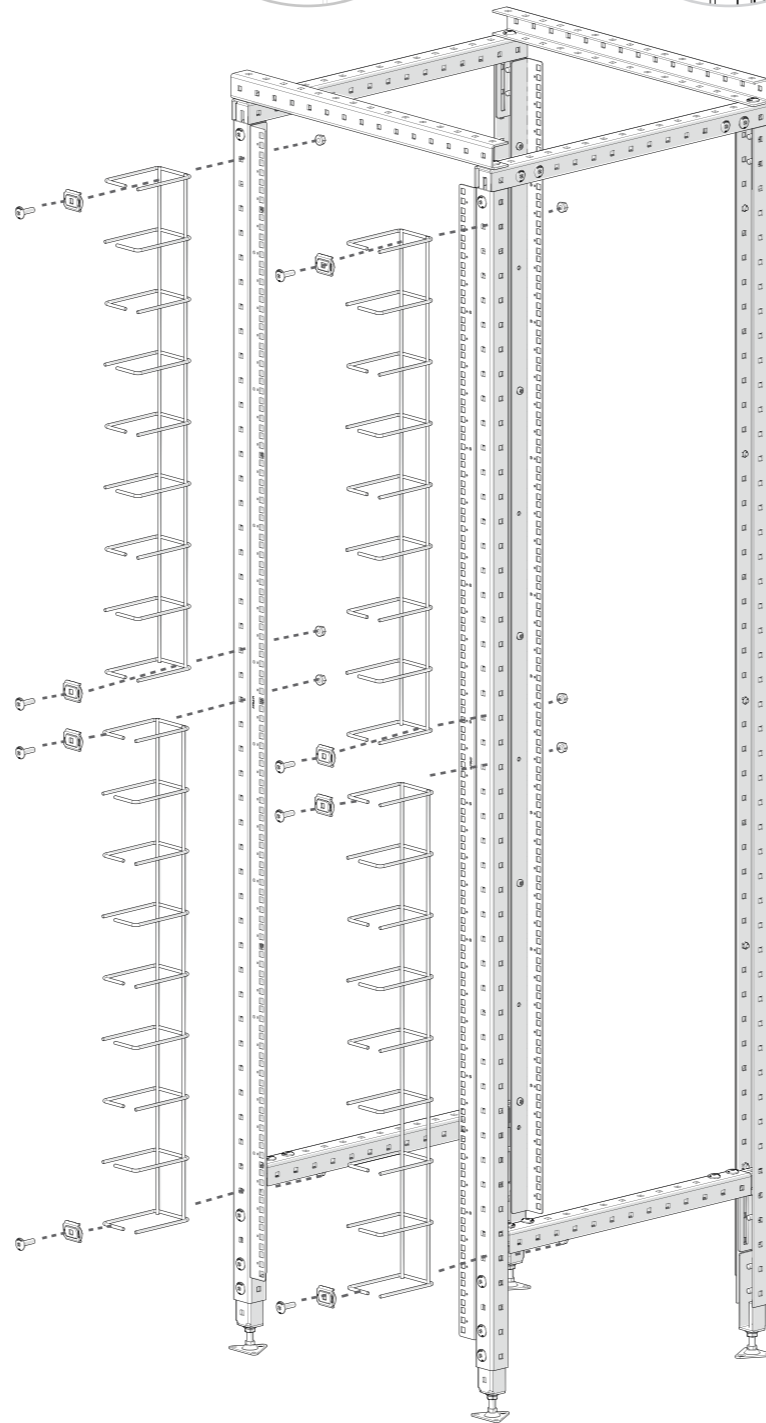
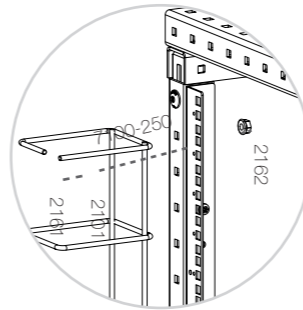
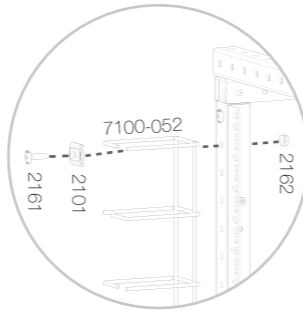
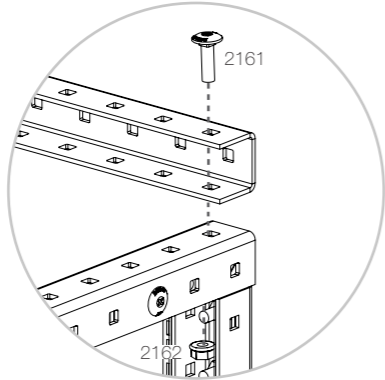
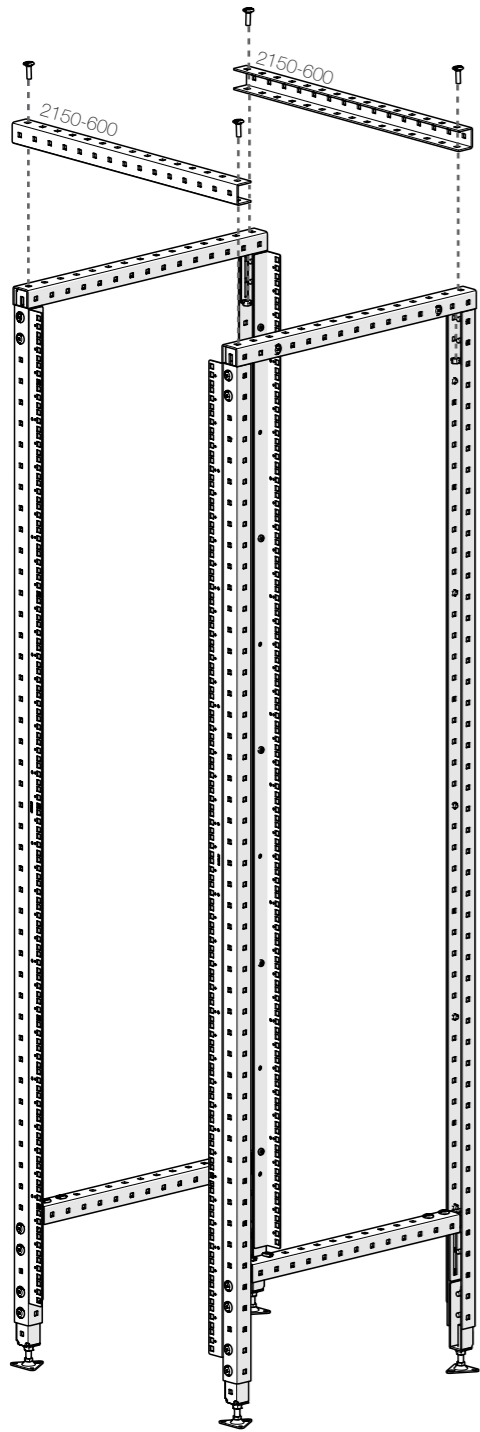

7100-200  
E: 1133514

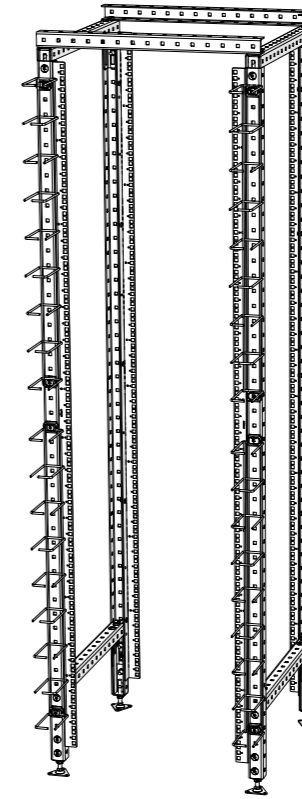

7100-201  
E: 1133515

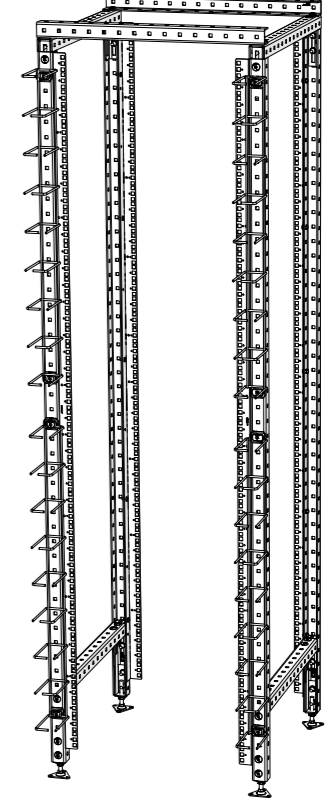

7100-204  
E: 1132933

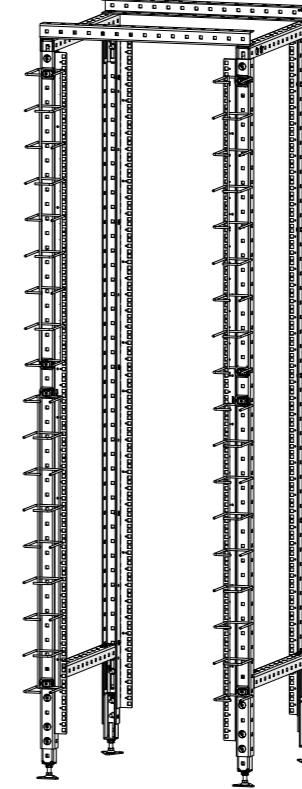

7100-205  
E: 1132946

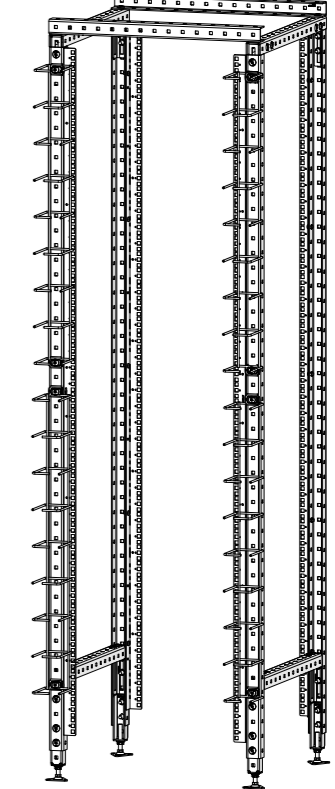



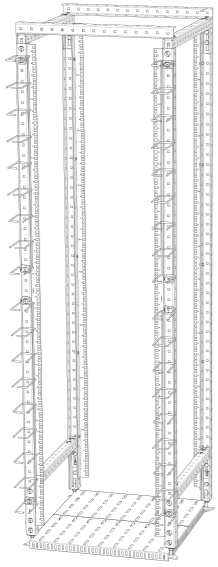

**7100-202**  
E: 1132947

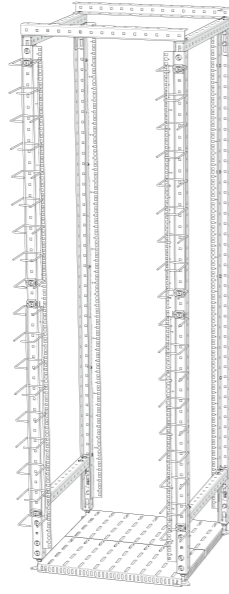

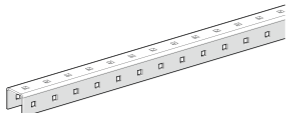
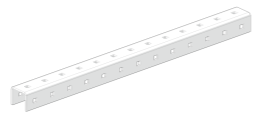
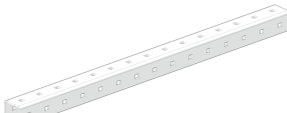
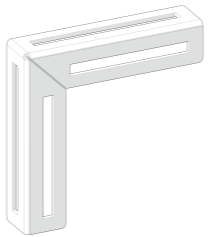
**7100-206**  
E: 1132948

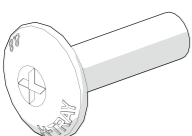
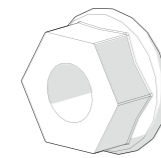
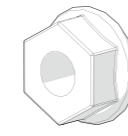
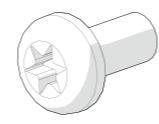
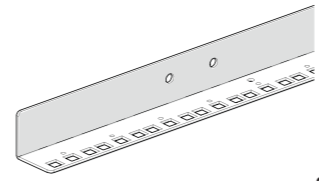
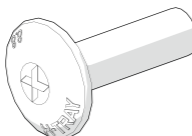
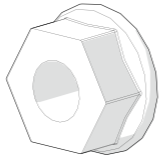

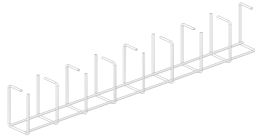
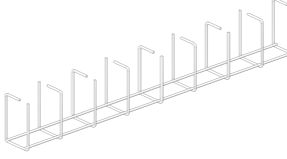
<p><b>7100-202/206</b> E: 1132947/ 1132948</p>	 2150-1920/2120 X4 E: 1133246 / 1133247	 2150-520 X2 E: 1133240	 2150-600 X4 E: 1133241	 2152 X8 E: 1133251	 2153 X4 E: 1133252
	 2161 X44 E: 1133257	 2162 X44 E: 1133258	 7100-056 X20 E: 1133497	 7100-057 X20 E: 1133498	 7100-050/051 X2 E: 1133492 / 1133493
<p><b>7100-052/250</b> E: 1133494/ 1132952 x 4</p>	 2161 X2 E: 1133257	 2162 X2 E: 1133258	 2101 X2 E: 1133211	 01-7100-052 X1	 01-7100-250 X1

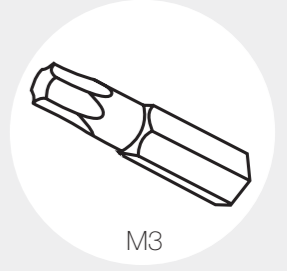

1

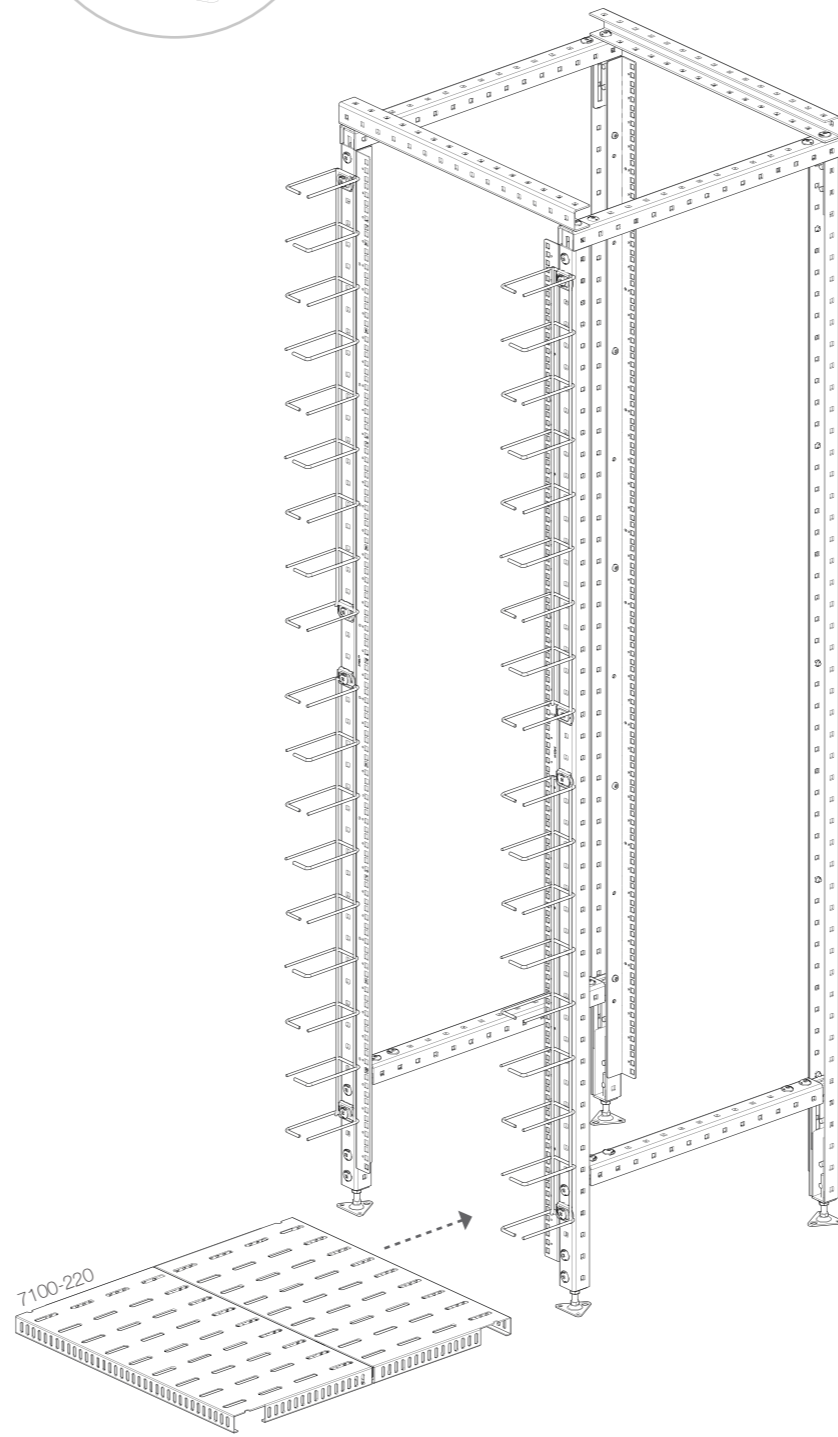
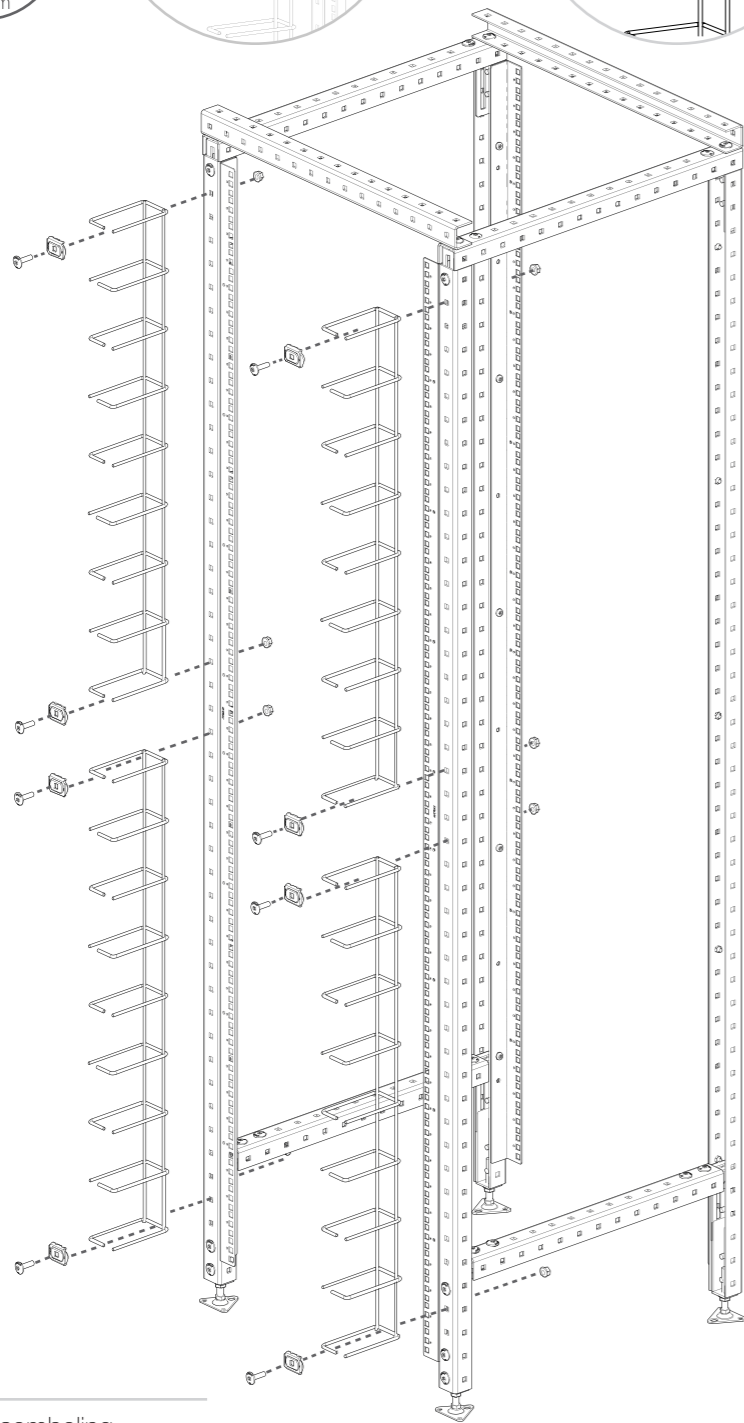
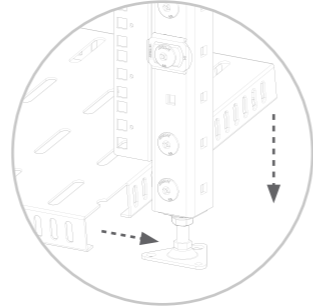
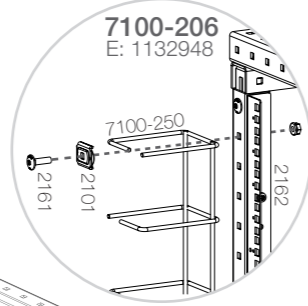
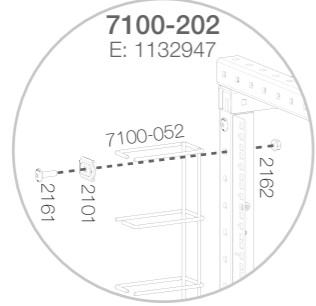

7100-202  
E: 1132947

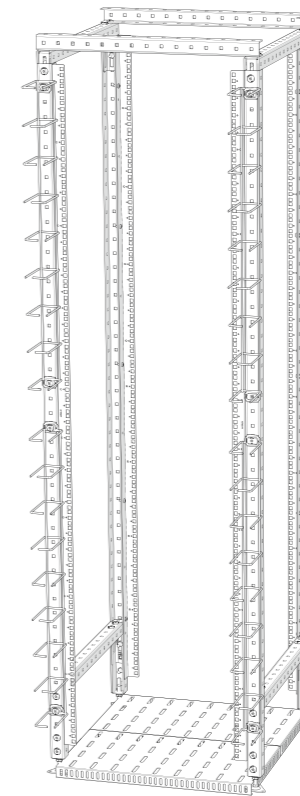

7100-206  
E: 1132948

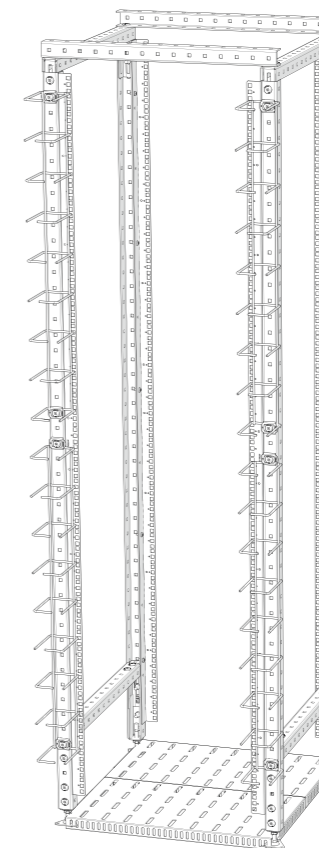

Assembling  
X-Rack side, Page: 5



**7100-054**  
E: 1133495

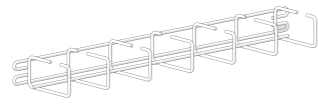

7100-054  
E: 1133495

X1

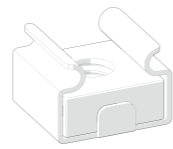

7100-055  
E: 1133496

X2

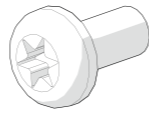

7100-057  
E: 1133498

X2

**7100-221**  
E: 1132951

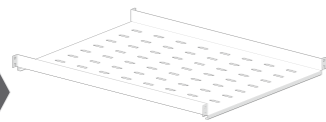

7100-221  
E: 1132951

X1

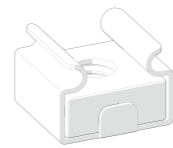

7100-055  
E: 1133496

X4

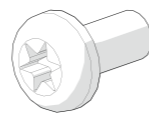

7100-057  
E: 1133498

X4

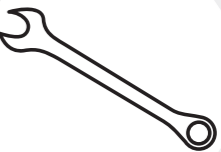
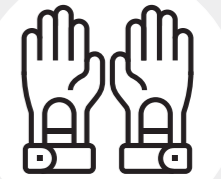
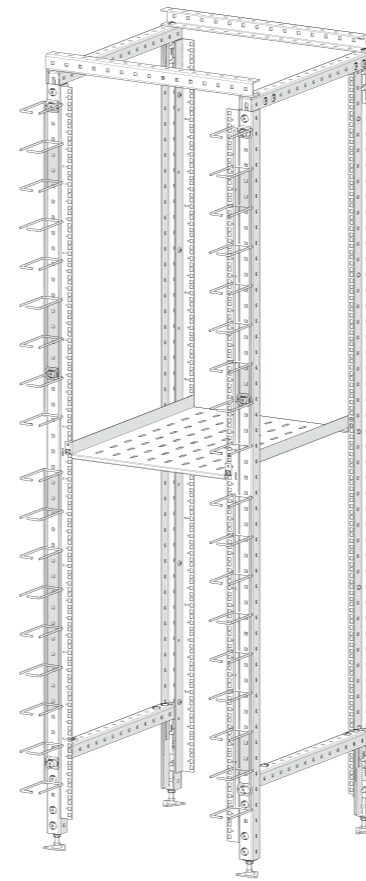
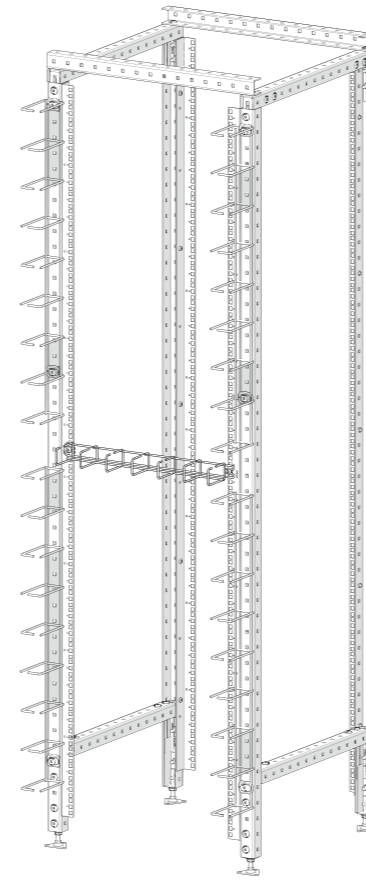

10/13mm

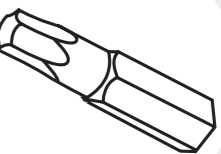

M3

**7100-054**  
E: 1133495

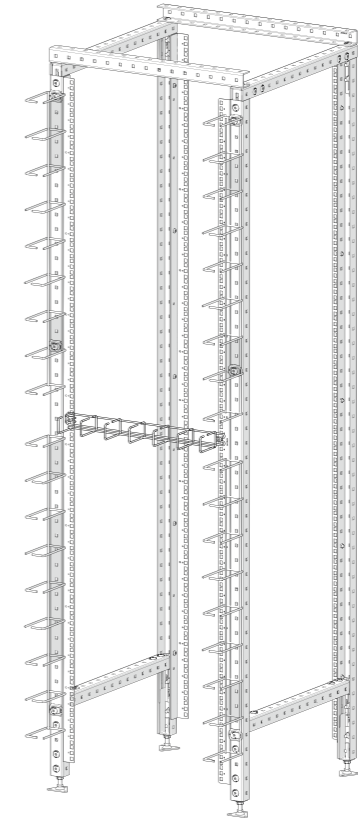
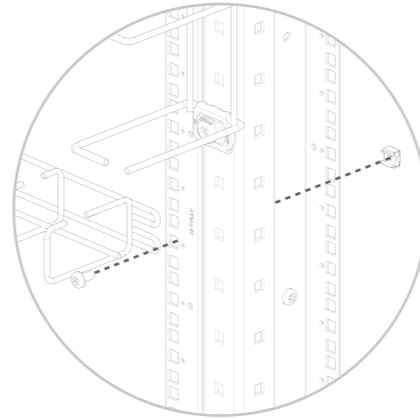
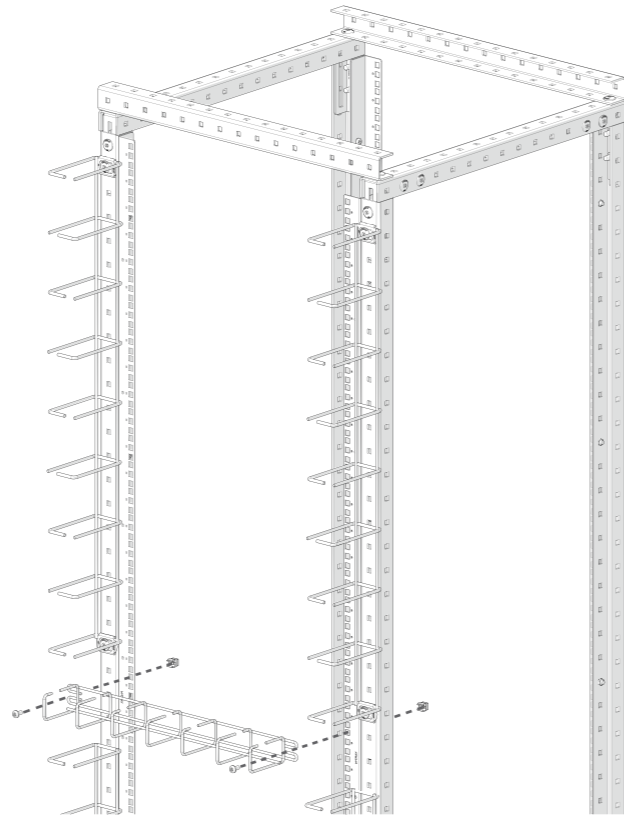
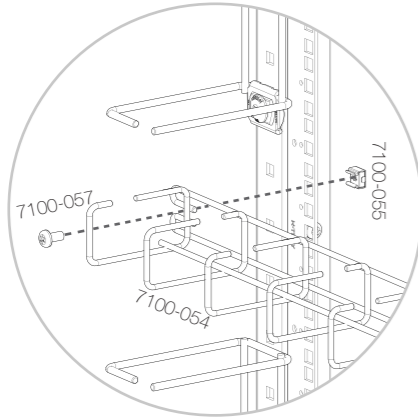
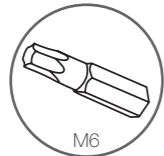

**7100-221**  
E: 1132951

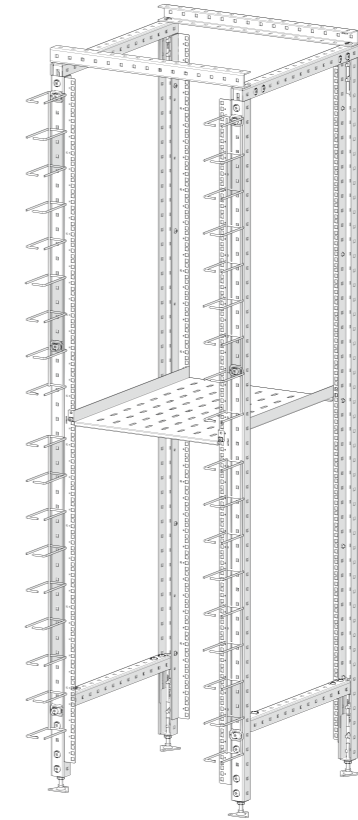
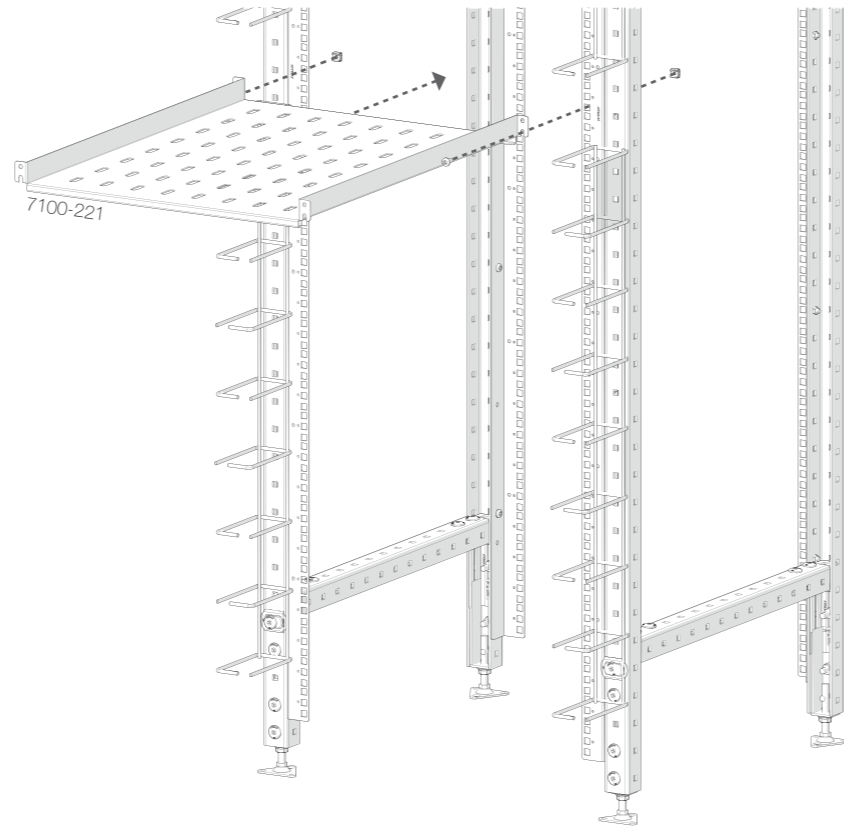
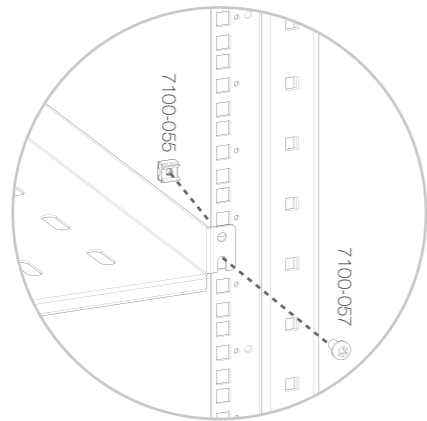
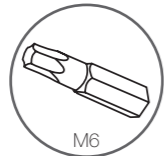

# X60

2160-120, E: 1133253  
2160-220, E: 1133254  
2160-320, E: 1133255  
2160-420, E: 1133256

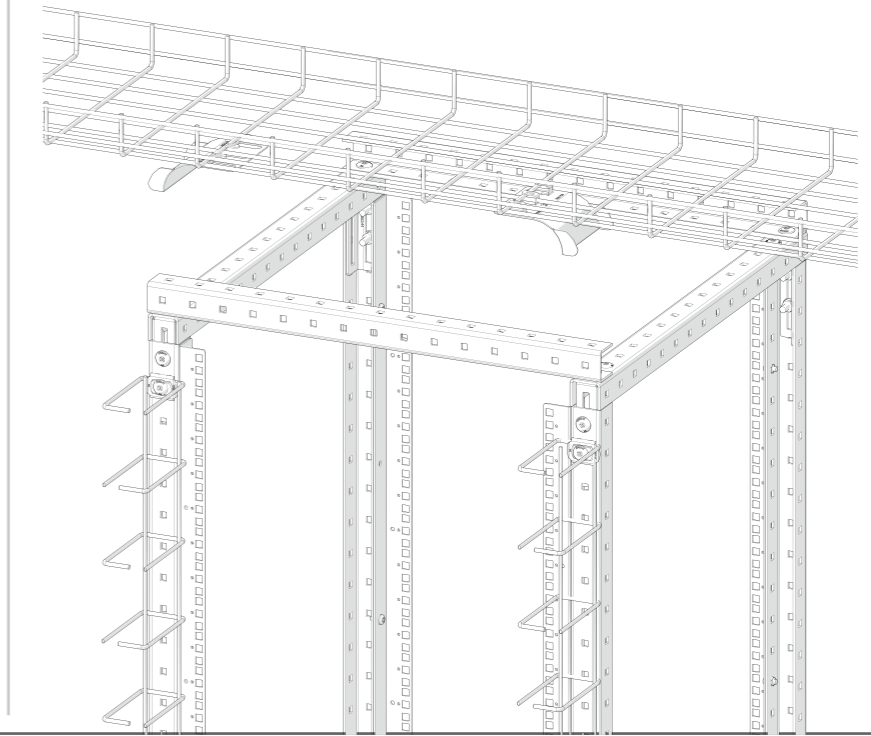
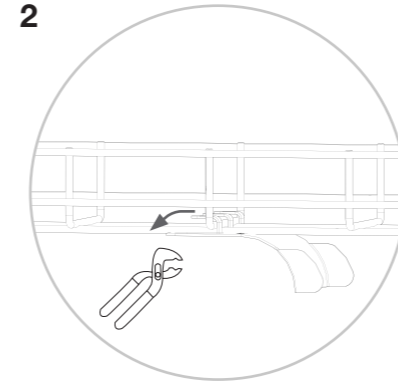
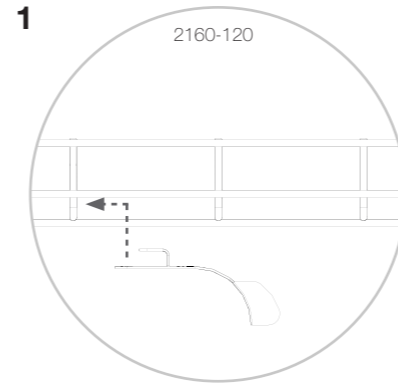
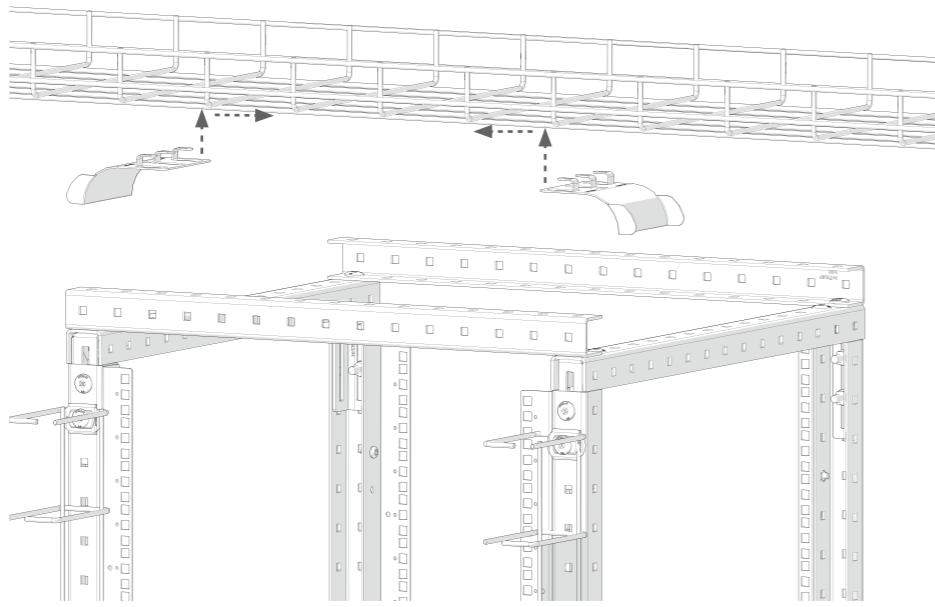

# X69

2169, E: 1132932

