



# Axelent X-Tray<sup>®</sup> **Technical**

Technical Information and Assembly Instructions

Version  
2.0  
English SE



## Table of Contents

<b>Tested and Approved</b>	4	<b>X1</b>	Fitting	16	<b>X52</b>	U-Bar Corner Fitting	23
<b>Corrosivity Classifications</b>	5	<b>X2</b>	Fitting	16	<b>X53</b>	U-Bar Adjustable Foot	24
<b>Overview Cable Trays</b>	6	<b>X3</b>	Angle Fitting	16	<b>X54</b>	U-Bar End Cap	24
<b>Overview Accessories</b>	7	<b>X4</b>	Fitting	16	<b>X55</b>	U-Bar Angle Fitting	24
<b>Product Information</b>	8	<b>X5</b>	Joining Bracket	16	<b>X60</b>	Radius Limiter	24
<b>Cutting</b>	8	<b>X10</b>	Bracket	17	<b>X61</b>	Carriage Bolt	25
<b>Cable Trays</b>	9-15	<b>X11</b>	Pendant Premium	18	<b>X62</b>	Flange Nut	25
<b>Fittings</b>	16	<b>X12</b>	Pendant Flexible	20	<b>X63</b>	Accessories Holder	26
<b>Mountings</b>	17-21	<b>X13</b>	Side Support	20	<b>X63</b>	Accessories Holder Mini	27
<b>Threaded Rod</b>	22	<b>X14</b>	Pendant	18	<b>X64</b>	L-Divider	29
<b>U-Bar</b>	23-24	<b>X15</b>	Cantilever	19	<b>X65</b>	Cover	28
<b>Accessories</b>	24-30	<b>X16</b>	Floor Support	20	<b>X66</b>	Divider Flexible	29
<b>Tools</b>	31	<b>X17</b>	Support Hook 120-320	20	<b>X67</b>	Divider Clamp	29
<b>X-Tray Additional Layer</b>	32	<b>X18</b>	Support Hook 420-620	20	<b>X68</b>	Equipotential Bonding Screw	29
<b>Others</b>	33	<b>X19</b>	Cantilever Low	21	<b>X69</b>	Side Radius Limiter	29
<b>Mounting - Hygiene</b>	34-36	<b>X30</b>	Threaded Rod	22	<b>X70</b>	Marking Clip	30
<b>Assembly - Hygiene</b>	36-37	<b>X31</b>	Threaded Rod Support Hook	22	<b>X72</b>	Safety Cap	30
<b>X-Rack</b>	38-43	<b>X33</b>	Threaded Rod Adapter	22	<b>X75-77</b>	Tools	31
<b>Joining</b>	44-45	<b>X34</b>	Ceiling Fitting	22	<b>X80</b>	Side Accessories Holder	27
<b>Corner - Angle</b>	46-47	<b>X35</b>	Threaded Rod Distance Nut	22	<b>X81</b>	Bending Plate	30
<b>Radius</b>	48-49	<b>X36</b>	Threaded Rod Beam Clamp	22			
<b>Reduction - Angle</b>	50	<b>X50</b>	U-Bar	23			
<b>T-junction</b>	51	<b>X51</b>	U-Bar Joining Fitting	23			
<b>Mounting</b>	52-57						
	60-62						
<b>Assembly</b>	58-59						
<b>Assembly Accessories</b>	62-66						
<b>Equipotential Bonding</b>	67						



# Tested and Approved

X-Tray complies with the highest demands on cable routing systems as laid down in IEC 61537.

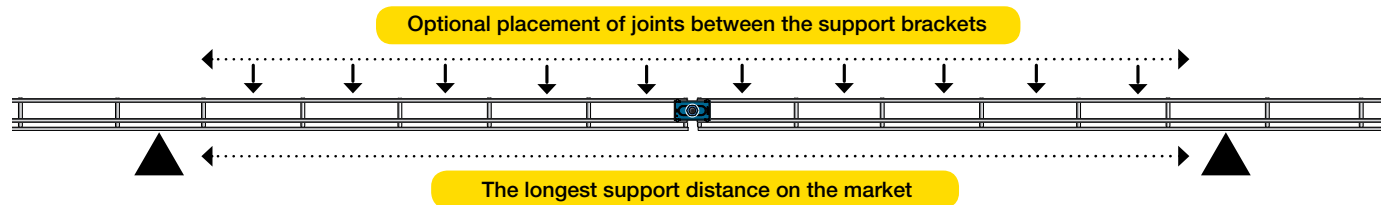

## IEC Cable management IEC 61537 – Cable tray systems

"This international standard specifies requirements and tests for cable tray systems intended for the support and accommodation of cables and other electrical equipment in electrical and/or communication system installations."

The strength of the wire trays and mountings makes their installation simple, strong and economical. Bracket spacing can be increased, therewith reducing the amount of installation work and overall costs.

## Tests

In addition to the IEC, we have tested and certified our trays in the following areas:

- Material
- Welding
- Load
- Identification
- EMC
- Coating
- Vibrations
- Fire

Visit our website [axelent.com](http://axelent.com) to read more about every specific tests under: "X-Tray Tested and Approved".

## Certified by:



\*Our UL certification also gives us NEMA APPROVAL.

## Load Diagram

The diagram below displays the recommended loading values with an evenly spaced load and free location of supports relative to the joiners. Values are in accordance with deflection rates outlined in IEC61537 and allow for a safety factor 1.7 x the stated load.

- **X-Tray® Height 110 mm**  
59 kg/m. Recommended support distance 2.5 m.
- **X-Tray® Height 60 mm with 5 mm wire**  
41 kg/m. Recommended support distance 2.25 m.
- **X-Tray® Height 60 mm with 4 mm wire**  
24 kg/m. Recommended support distance 2.25 m.
- **X-Tray® Height 30 mm with 5 mm wire**  
21 kg/m. Recommended support distance 1.75 m.
- **X-Tray® Height 30 mm with 4 mm wire**  
18 kg/m. Recommended support distance 1.75 m.

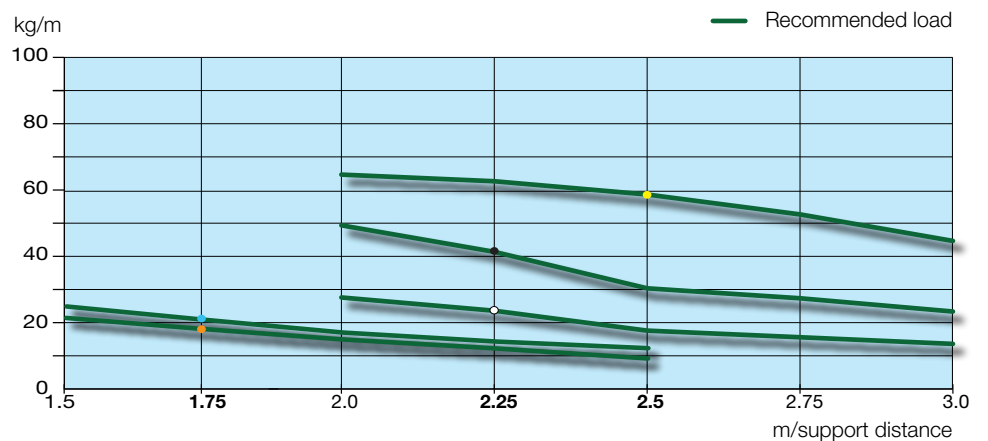

## Axelent is a member of EHEDG

Axelent is one of 1,300 members of EHEDG (European Hygienic Engineering and Material Group). EHEDG (founded in 1989) is a European non-government organisation whose purpose is to promote hygienic Material and foodstuffs technology, so that safe products are brought out to the consumer.





# X-Tray covers all corrosion classifications

Corrosivity classifications according to SS-EN ISO 12944-2

Corrosivity classification	C1	C2	C3	C4	C5	CX
Environmental corrosivity	Very low	Low	Moderate	High	Very high	Extreme
Outdoors	-	Low concentrations of air pollution, rural areas	Moderate amounts of air pollution. Urban areas and light industry areas	Considerable amounts of air pollution or moderate amounts of salt, industry and coastal regions.	Industrial areas with harsh climates and high humidity. Coastal and offshore areas with large amounts of salt	Extreme industrial, coastal and offshore areas in subtropical and tropical climates with salt and contamination, lap zones
Indoor	Heated areas with dry air and insignificant amounts of contaminants. E.g., offices, stores, schools, hotels	Non-heated areas with fluctuating temperatures and humidity. E.g., sports arenas, storage premises	Moderate humidity and certain amounts of air pollution. E.g., breweries, dairies, laundries, heated ice skating arenas	High humidity and large amounts of air contamination. E.g., chemical industries, indoor swimming pools, shipyards unheated skating arenas	Permanent moisture condensation and large amounts of air pollution	Extreme humidity condensation and extremely harsh climate
Recommended material/coating	Zinc Plated – Fzb	Sendzimir	Hot Dip galv. / Zinc-nickel Fzv		Stainless 304L	Stainless 316L

## Selection of material



The selection of material/coating is affected by several factors. Humidity and salt in the air have a major impact, and in certain environments, there may even be substances that have properties that considerably shorten the lifespan of the coating, which must be taken into account. That is why it is important to establish the corrosivity and corrosivity class according to SS-EN ISO 12944-2 in order to select the coating.

Recommended material/coating is a guide for choosing a material/coating that has a long lifespan as cost-effectively as possible.

### Zinc plating

Zinc plating involves the application of a thin layer of zinc that provides a basic level of protection.

According to standard: [SS-EN ISO 2081:2008](#), [DIN 50961](#), [DIN-EN 12329](#)

### Sendzimir

A method for hot dip galvanising of sheet metal. Often called galvanised steel.

According to standard: [SS-EN 10327:2004](#)

### Hot dip galvanisation

Involves the application of a thick layer of zinc by dipping the steel into a heated zinc bath. If damages occur to the surface, the zinc has the capacity to repair itself.

According to standard: [SS-EN ISO 1461:2009](#), [DIN 50976](#)

### Zinc/Nickel

Zinc/nickel is a thin coating that contains 12-15% nickel and has the same qualities as or somewhat better qualities than hot galvanised.

Used on many of the accessories where it is important that narrow tolerances will be maintained, for example for screws and nuts.

According to standard: [SS-EN ISO 11997-1](#), [DIN 50979](#)

### Stainless 304L

Material is 304L, EN-no 1.4307, acid. X-Tray has no accessories in 304L; rather, they are always 316L.

According to standard: [SS 2352 / AISI 304L](#)

### Stainless 316L

Material is 316L, EN-no 1.4404, and is pickling by dipping it into an acid bath, this creates a surface without contamination that is easy to clean. Appropriate for use in environments with high demands on hygiene, for example the pharmaceutical and food industries.

According to standard: [SS 2348 SF / AISI 316L](#)

# Overview X-Tray Cable trays

Even when working on the basis of the standards, there are always occasions when it is necessary to go further with specially customised solutions. The standard length is 2500 mm, but everything can be customised to your needs as a customer. X-Tray has no limitations.

## U-Trays height 30 - 110 mm

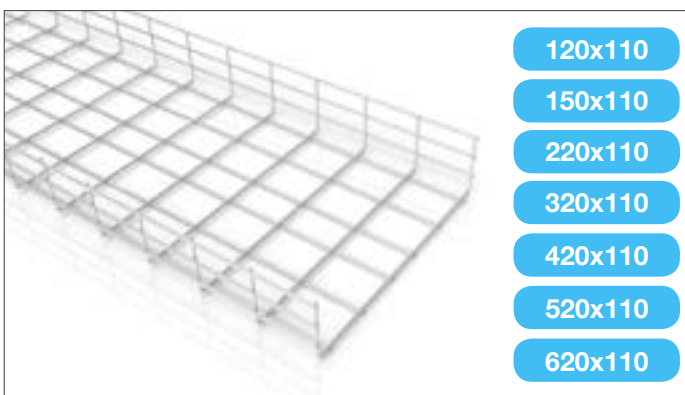
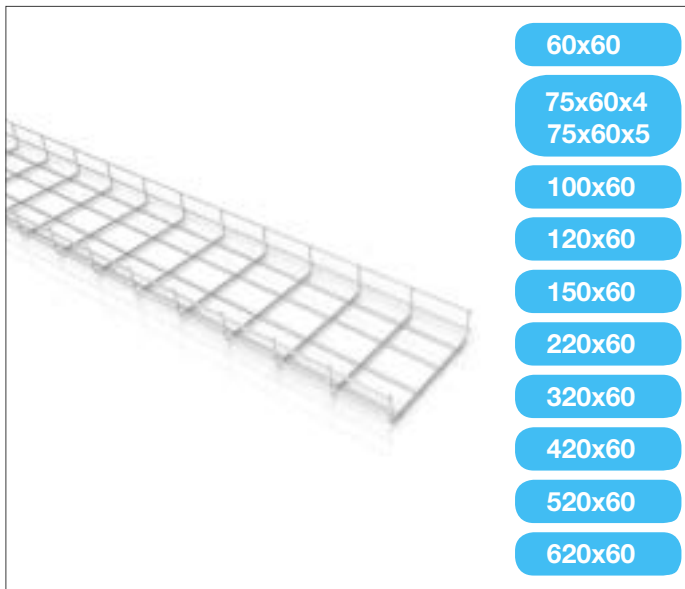
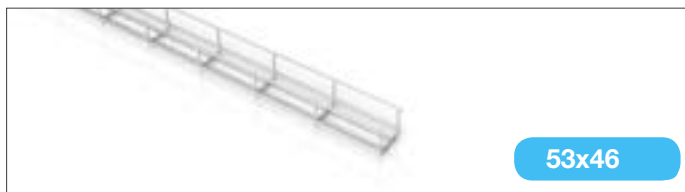
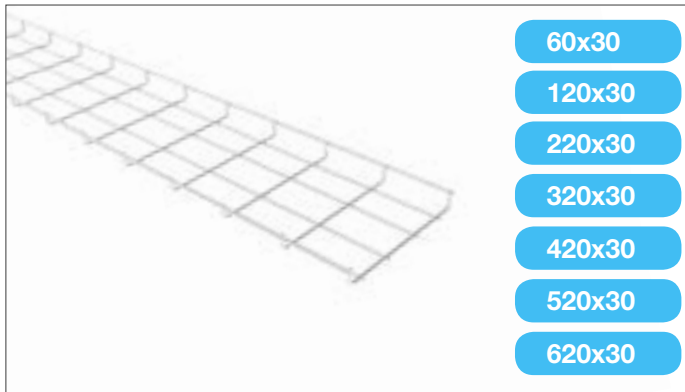

## Flat-Trays

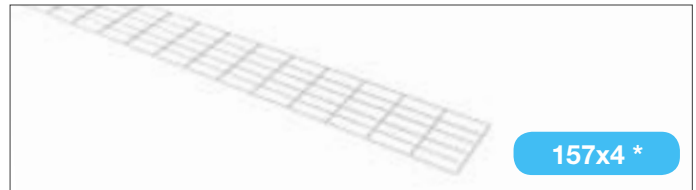

\* Can be customised according to desired width and length. Delivery time will be added.

## Mini-Trays



## C-Trays



## G-Trays



## Z-Trays

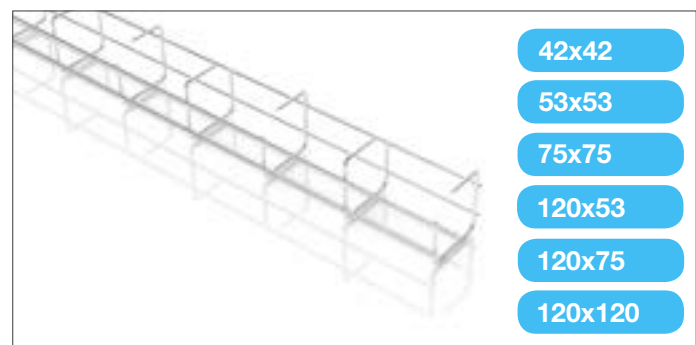

# Overview X-Tray Accessories

The accessories are Material protected. Subject to change without prior notice.

## Brackets

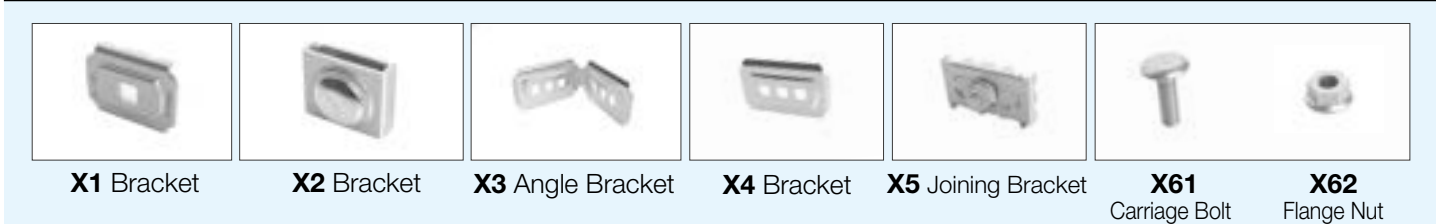

## Mounting

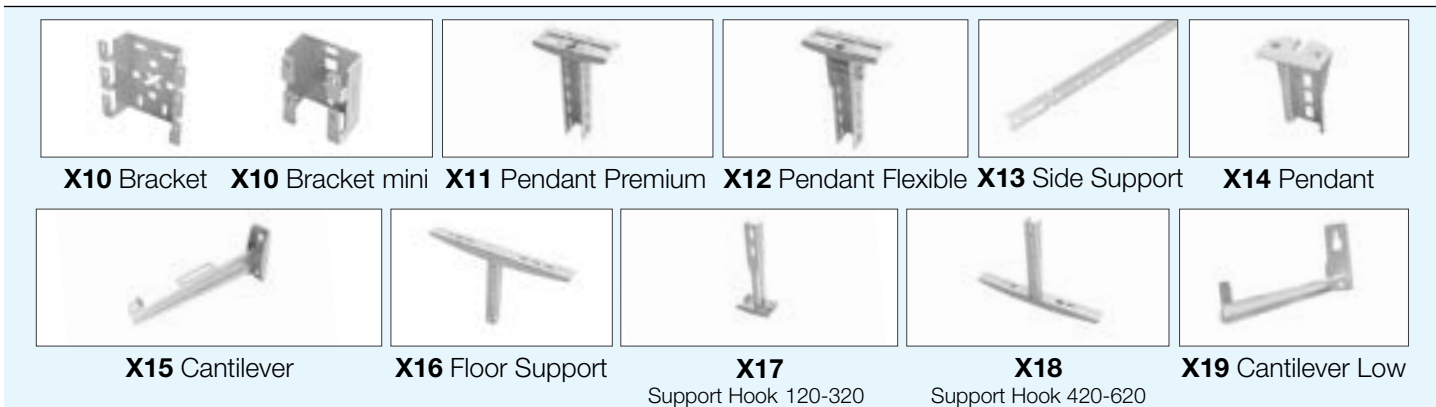

## Threaded Rod

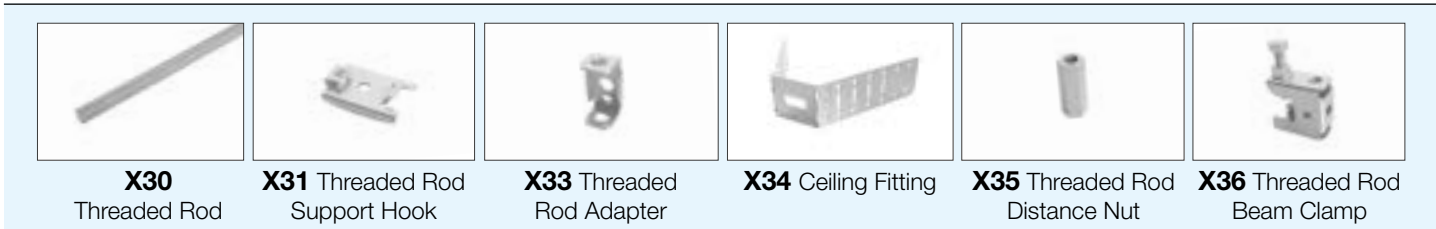

## U-Bar

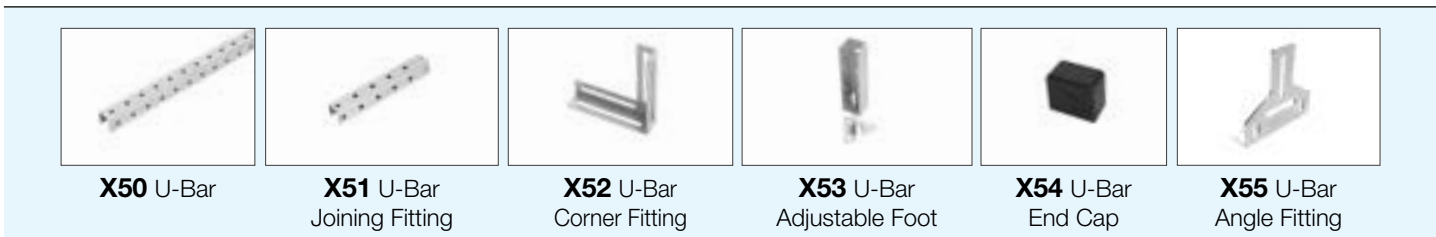

## Other accessories

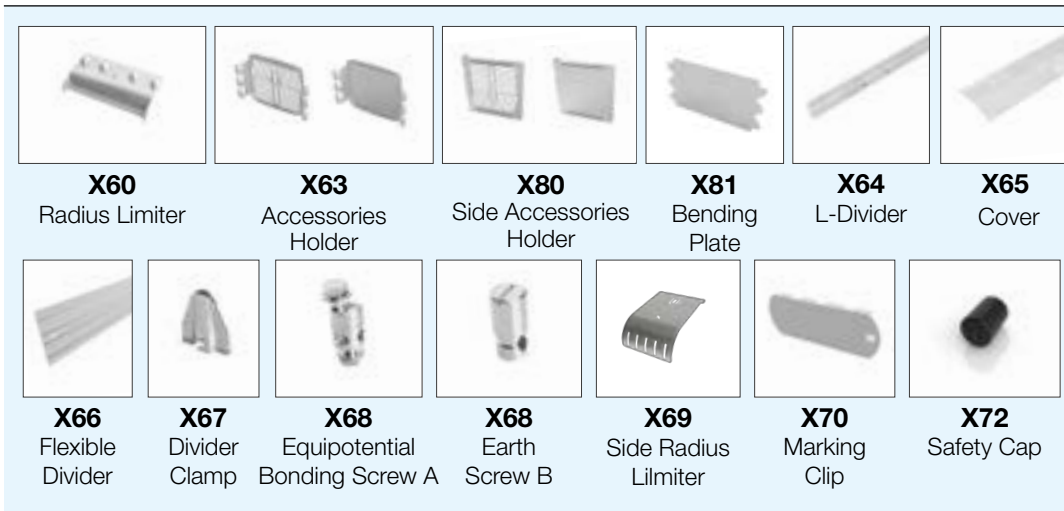

## Tools



# X-TRAY® PRODUCT INFO

## Choice of wire tray

Consider the following when choosing wire trays

### Environment



Environmental requirements for surface treatment and/or classification of installation are based on standards, use, surroundings or specified requirements.

### Weight/volume

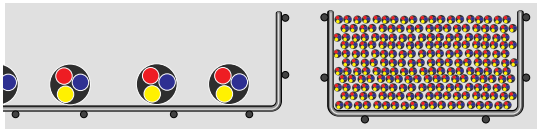

Weight and volume of cables taking into account future needs.

### Extra weight



Extra weight from point loads.

### Installation

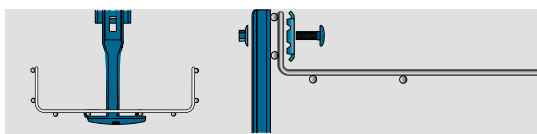

A complete system where few components solve installations against walls, from ceilings or on floors.

### Bracket distance

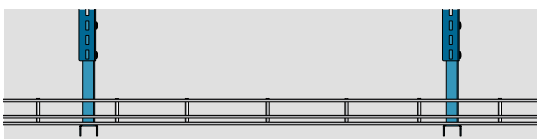

Greater distance between the brackets means less work and lower costs. We recommend a bracket spacing of 2.25 m.

### Equipotential bonding

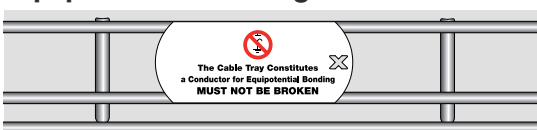

Tested for equipotential bonding. See page 67.

## Cutting

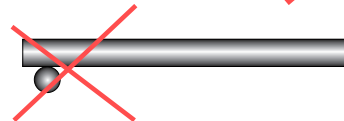
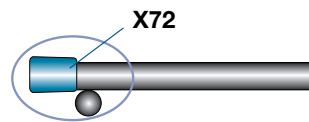
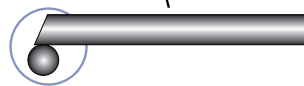
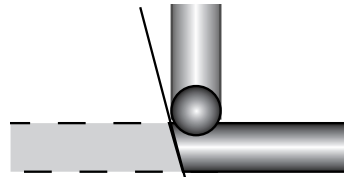
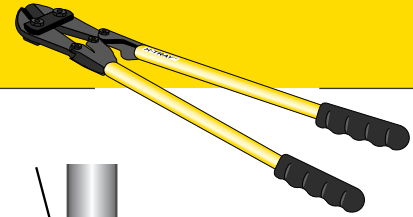

## X77 Wire cutting machine

Cuts quickly and easily without leaving any sharp edges Unique tool that we always have in inventory.

Contact us for more information of to test a demo machine.





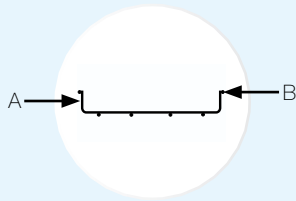

All measures in mm.  
All measures are taken from the outer edges of the cable trays.  
Width x height.  
A & B = Wire diameter (Ø).

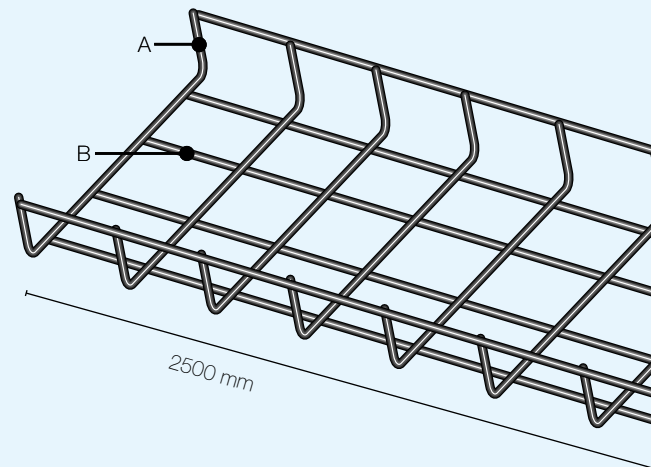

Cable Trays

### 60x30 L=2500mm | A = Ø 4, B = Ø 4

Material	Item No.	E-number
Zinc Plated Fzb	0100	1133029
Hot Dip galv. Fzv	0200	1133036
Stainless 316L	0300	1133043
Stainless 304L	0400	1133050



### 420x30 L=2500mm | A = Ø 5, B = Ø 6

Material	Item No.	E-number
Zinc Plated Fzb	0140	1133033
Hot Dip galv. Fzv	0240	1133040
Stainless 316L	0340	1133047
Stainless 304L	0440	1133054

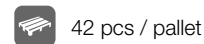

### 120x30 L=2500mm | A = Ø 5, B = Ø 5

Material	Item No.	E-number
Zinc Plated Fzb	0110	1133030
Hot Dip galv. Fzv	0210	1133037
Stainless 316L	0310	1133044
Stainless 304L	0410	1133051

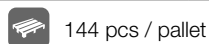

### 520x30 L=2500mm | A = Ø 5, B = Ø 6

Material	Item No.	E-number
Zinc Plated Fzb	0150	1133034
Hot Dip galv. Fzv	0250	1133041
Stainless 316L	0350	1133048
Stainless 304L	0450	1133055

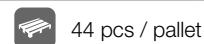

### 220x30 L=2500mm | A = Ø 5, B = Ø 5

Material	Item No.	E-number
Zinc Plated Fzb	0120	1133031
Hot Dip galv. Fzv	0220	1133038
Stainless 316L	0320	1133045
Stainless 304L	0420	1133052

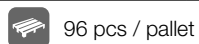

### 620x30 L=2500mm | A = Ø 5, B = Ø 6

Material	Item No.	E-number
Zinc Plated Fzb	0160	1133035
Hot Dip galv. Fzv	0260	1133042
Stainless 316L	0360	1133049
Stainless 304L	0460	1133056

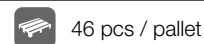

### 320x30 L=2500mm | A = Ø 5, B = Ø 5

Material	Item No.	E-number
Zinc Plated Fzb	0130	1133032
Hot Dip galv. Fzv	0230	1133039
Stainless 316L	0330	1133046
Stainless 304L	0430	1133053

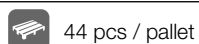

# X-TRAY® 46

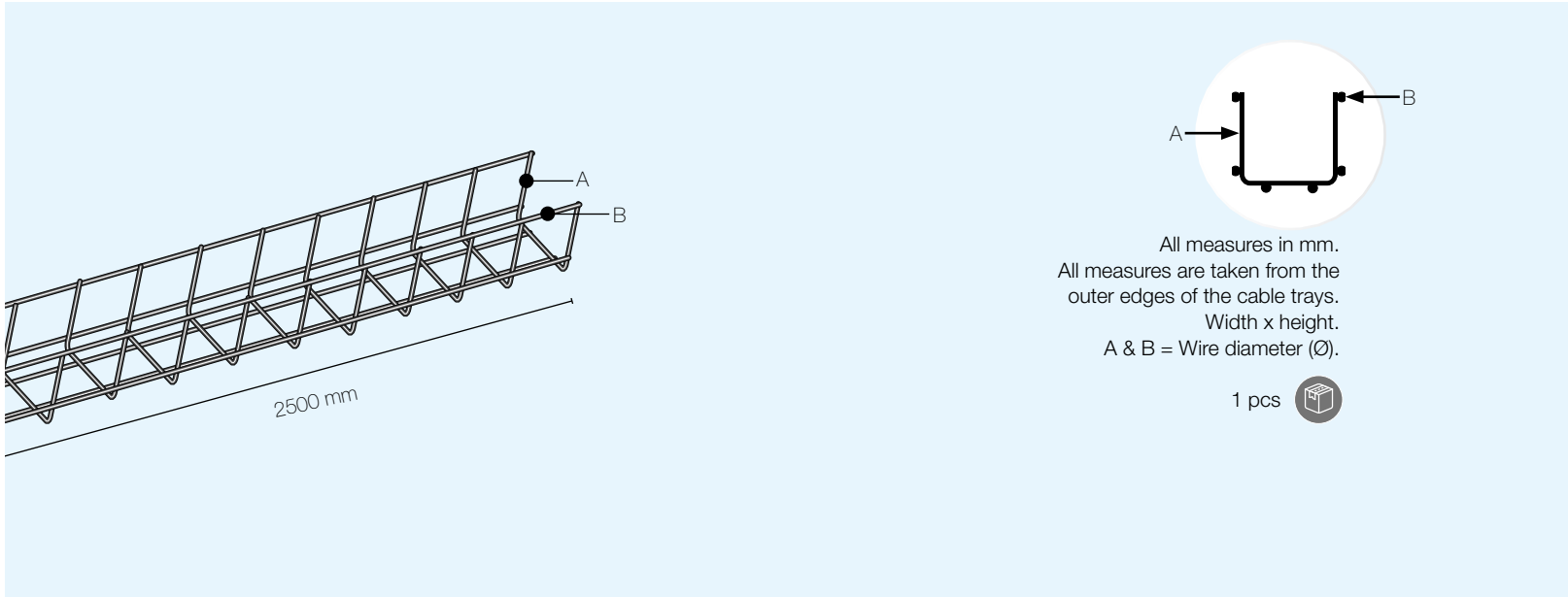

All measures in mm.  
All measures are taken from the outer edges of the cable trays.  
Width x height.  
A & B = Wire diameter (Ø).

1 pcs

**53X46** L=2500mm | A = Ø 4, B = Ø 4

Material	Item No.	E-number
Zinc Plated Fzb	0199-053	1133111
Hot Dip galv. Fzv	0299-053	1133125
Stainless 316L	0399-053	1133139
Stainless 304L	0499-053	1133153

280 pcs / pallet

# X-TRAY® 60

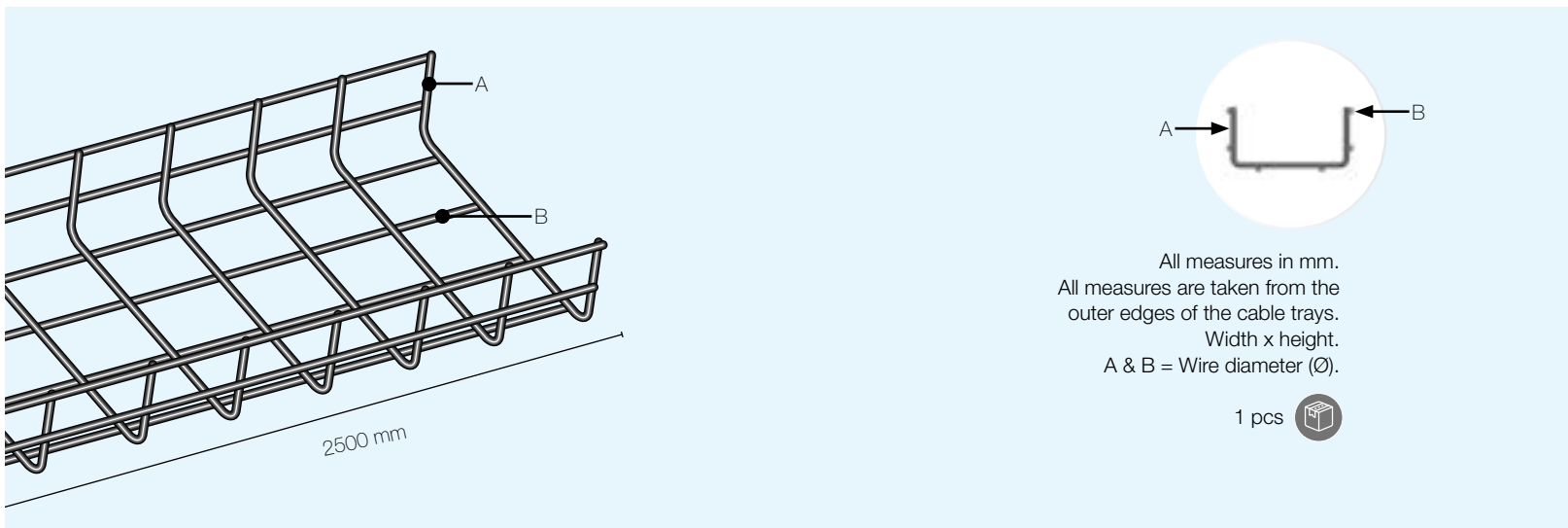

All measures in mm.  
All measures are taken from the outer edges of the cable trays.  
Width x height.  
A & B = Wire diameter (Ø).

1 pcs

**60x60** L=2500mm | A = Ø 4, B = Ø 4

Material	Item No.	E-number
Zinc Plated Fzb	0101	1133100
Hot Dip galv. Fzv	0201	1133114
Stainless 316L	0301	1133128
Stainless 304L	0401	1133142

198 pcs / pallet

## 75x60 L=2500mm | A = Ø 4, B = Ø 4

Material	Item No.	E-number
Zinc Plated Fzb	0199-0754	1133112
Hot Dip galv. Fzv	0299-0754	1133126
Stainless 316L	0399-0754	1133140
Stainless 304L	0499-0754	1133154

 198 pcs / pallet

## 75x60 L=2500mm | A = Ø 5, B = Ø 5

Material	Item No.	E-number
Zinc Plated Fzb	0199-0755	1133113
Hot Dip galv. Fzv	0299-0755	1133127
Stainless 316L	0399-0755	1133141
Stainless 304L	0499-0755	1133155

 198 pcs / pallet

## 100x60 L=2500mm | A = Ø 5, B = Ø 5

Material	Item No.	E-number
Zinc Plated Fzb	0191-100	1133442
Hot Dip galv. Fzv	0291-100	1133454
Stainless 316L	0391-100	1133459
Stainless 304L	0491-100	1133464

 168 pcs / pallet

## 120x60 L=2500mm | A = Ø 5, B = Ø 5

Material	Item No.	E-number
Zinc Plated Fzb	0111	1133101
Hot Dip galv. Fzv	0211	1133115
Stainless 316L	0311	1133129
Stainless 304L	0411	1133143

 144 pcs / pallet

## 150x60 L=2500mm | A = Ø 5, B = Ø 5

Material	Item No.	E-number
Zinc Plated Fzb	0191-150	1133443
Hot Dip galv. Fzv	0291-150	1133455
Stainless 316L	0391-150	1133460
Stainless 304L	0491-150	1133465

 120 pcs / pallet

## 220x60 L=2500mm | A = Ø 5, B = Ø 5

Material	Item No.	E-number
Zinc Plated Fzb	0121	1133103
Hot Dip galv. Fzv	0221	1133117
Stainless 316L	0321	1133131
Stainless 304L	0421	1133145

 98 pcs / pallet

## 320x60 L=2500mm | A = Ø 5, B = Ø 5

Material	Item No.	E-number
Zinc Plated Fzb	0131	1133105
Hot Dip galv. Fzv	0231	1133119
Stainless 316L	0331	1133133
Stainless 304L	0431	1133147

 72 pcs / pallet

## 420x60 L=2500mm | A = Ø 5, B = Ø 6

Material	Item No.	E-number
Zinc Plated Fzb	0141	1133107
Hot Dip galv. Fzv	0241	1133121
Stainless 316L	0341	1133135
Stainless 304L	0441	1133149

 44 pcs / pallet

## 520x60 L=2500mm | A = Ø 5, B = Ø 6

Material	Item No.	E-number
Zinc Plated Fzb	0151	1133440
Hot Dip galv. Fzv	0251	1133452
Stainless 316L	0351	1133457
Stainless 304L	0451	1133462

 20 pcs / pallet

## 620x60 L=2500mm | A = Ø 5, B = Ø 6

Material	Item No.	E-number
Zinc Plated Fzb	0161	1133441
Hot Dip galv. Fzv	0261	1133453
Stainless 316L	0361	1133458
Stainless 304L	0461	1133463

 20 pcs / pallet

# X-TRAY® 110

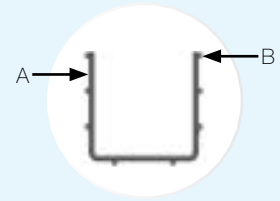
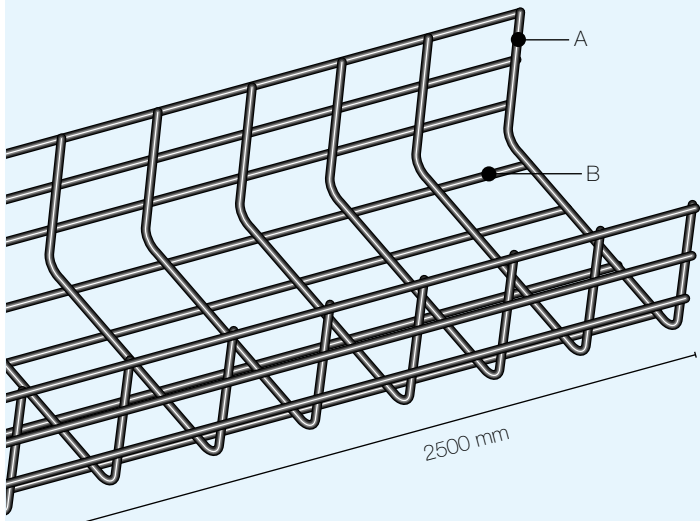

All measures in mm.  
All measures are taken from the  
outer edges of the cable trays.  
Width x height.  
A & B = Wire diameter (Ø).

1 pcs 

## 120x110 L=2500mm | A = Ø 5, B = Ø 5

Material	Item No.	E-number
Zinc Plated Fzb	0112	1133102
Hot Dip galv. Fzv	0212	1133116
Stainless 316L	0312	1133130
Stainless 304L	0412	1133144

 84 pcs / pallet

## 150x110 L=2500mm | A = Ø 5, B = Ø 5

Material	Item No.	E-number
Zinc Plated Fzb	0192-150	1133444
Hot Dip galv. Fzv	0292-150	1133456
Stainless 316L	0392-150	1133461
Stainless 304L	0492-150	1133466

 76 pcs / pallet

## 220x110 L=2500mm | A = Ø 5, B = Ø 5

Material	Item No.	E-number
Zinc Plated Fzb	0122	1133104
Hot Dip galv. Fzv	0222	1133118
Stainless 316L	0322	1133132
Stainless 304L	0422	1133146

 48 pcs / pallet

## 320x110 L=2500mm | A = Ø 5, B = Ø 5

Material	Item No.	E-number
Zinc Plated Fzb	0132	1133106
Hot Dip galv. Fzv	0232	1133120
Stainless 316L	0332	1133134
Stainless 304L	0432	1133148

 36 pcs / pallet

## 420x110 L=2500mm | A = Ø 5, B = Ø 6

Material	Item No.	E-number
Zinc Plated Fzb	0142	1133108
Hot Dip galv. Fzv	0242	1133122
Stainless 316L	0342	1133136
Stainless 304L	0442	1133150

 24 pcs / pallet

## 520x110 L=2500mm | A = Ø 5, B = Ø 6

Material	Item No.	E-number
Zinc Plated Fzb	0152	1133109
Hot Dip galv. Fzv	0252	1133123
Stainless 316L	0352	1133137
Stainless 304L	0452	1133151

 12 pcs / pallet

## 620x110 L=2500mm | A = Ø 5, B = Ø 6

Material	Item No.	E-number
Zinc Plated Fzb	0162	1133110
Hot Dip galv. Fzv	0262	1133124
Stainless 316L	0362	1133138
Stainless 304L	0462	1133152

 12 pcs / pallet



# X-TRAY® FLAT

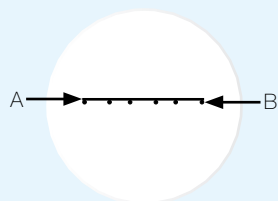

All measures in mm.  
All measures are taken from the outer edges of the cable trays.  
Width x height.  
A & B = Wire diameter (Ø).



\* Width and length, as well as wire thickness, can be customised as desired.

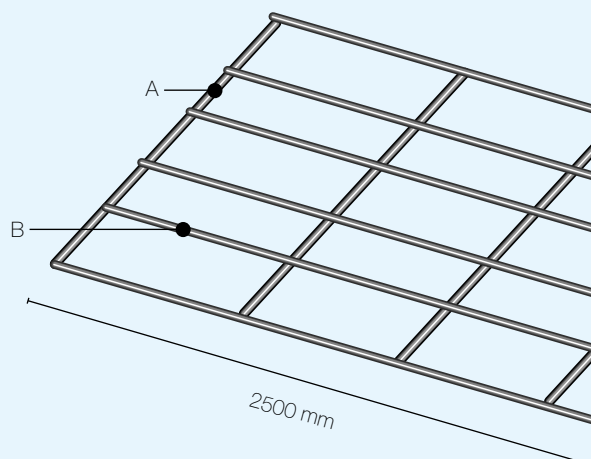

Cable Trays

**157** L=2500mm | A = Ø 4, B = Ø 4 \*

Material	Item No.	E-number
Zinc Plated Fzb	1161	1132911
Hot Dip galv. Fzv	1261	1132912
Stainless 316L	1361	1132913
Stainless 304L	1461	1132914

# X-TRAY® MINI

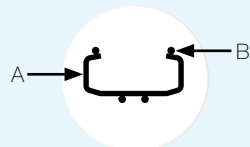

All measures in mm.  
All measures are taken from the outer edges of the cable trays.  
Width x height.  
A & B = Wire diameter (Ø).

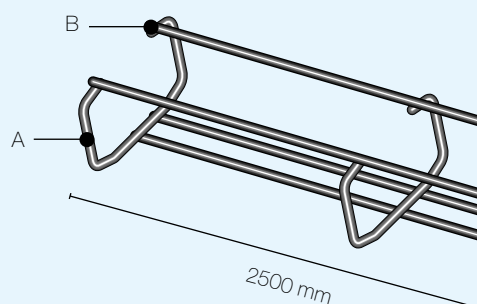

**30x22** L=2500mm | A = Ø 2,5, B = Ø 3

Material	Item No.	E-number
Zinc Plated Fzb	1152	1133175
Hot Dip galv. Fzv	1252	1133184
Stainless 316L	1352	1133192
Stainless 304L	1452	1133200

**40x32** L=2500mm | A = Ø 2,5, B = Ø 3

Material	Item No.	E-number
Zinc Plated Fzb	1154	1133178
Hot Dip galv. Fzv	1254	1133186
Stainless 316L	1354	1133194
Stainless 304L	1454	1133202

**40x22** L=2500mm | A = Ø 2,5, B = Ø 3

Material	Item No.	E-number
Zinc Plated Fzb	1153	1133177
Hot Dip galv. Fzv	1253	1133185
Stainless 316L	1353	1133193
Stainless 304L	1453	1133201

**Accessories** | Self-tapping Screw

Material	Item No.	E-number
Zinc Plated Fzb	7100-070	1132954

# X-TRAY® C

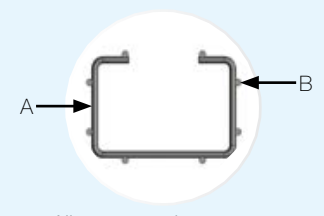
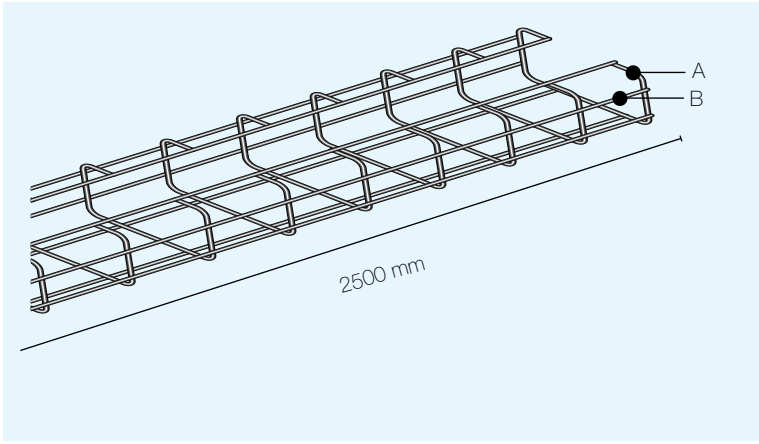

All measures in mm.  
All measures are taken from the outer edges of the cable trays.  
Width x height.  
A & B = Wire diameter (Ø).

1 pcs

**70x68** L=2500mm | A = Ø 4, B = Ø 4

Material	Item No.	E-number
Zinc Plated Fzb	1110	1133170
Hot Dip galv. Fzv	1210	1133179
Stainless 316L	1310	1133187
Stainless 304L	1410	1133195

200 pcs / pallet

**120x80** L=2500mm | A = Ø 5, B = Ø 5

Material	Item No.	E-number
Zinc Plated Fzb	1111	1133171
Hot Dip galv. Fzv	1211	1133180
Stainless 316L	1311	1133188
Stainless 304L	1411	1133196

96 pcs / pallet

**220x120** L=2500mm | A = Ø 5, B = Ø 5

Material	Item No.	E-number
Zinc Plated Fzb	1112	1133172
Hot Dip galv. Fzv	1212	1133181
Stainless 316L	1312	1133189
Stainless 304L	1412	1133197

48 pcs / pallet

# X-TRAY® G

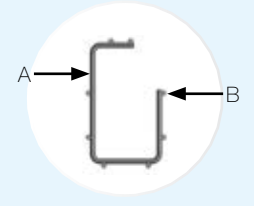
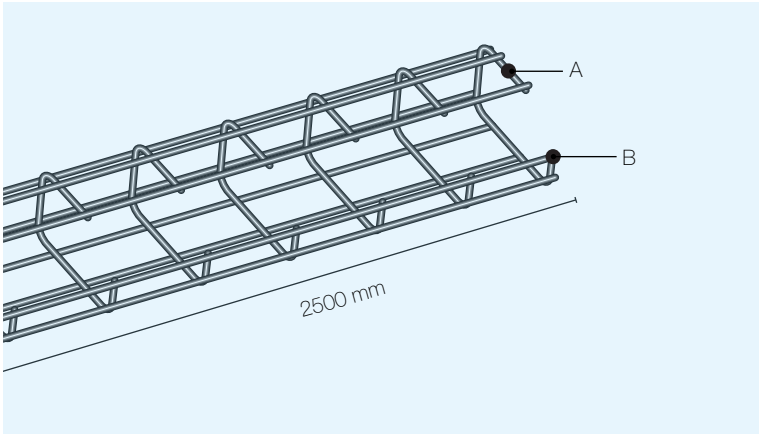

All measures in mm.  
All measures are taken from the outer edges of the cable trays.  
Width x height.  
A & B = Wire diameter (Ø).

1 pcs

**60x100** L=2500mm | A = Ø 4, B = Ø 4

Material	Item No.	E-number
Zinc Plated Fzb	1121	1133173
Hot Dip galv. Fzv	1221	1133182
Stainless 316L	1321	1133190
Stainless 304L	1421	1133198

196 pcs / pallet

**120x150** L=2500mm | A = Ø 5, B = Ø 5

Material	Item No.	E-number
Zinc Plated Fzb	1122	1133174
Hot Dip galv. Fzv	1222	1133183
Stainless 316L	1322	1133191
Stainless 304L	1422	1133199

72 pcs / pallet

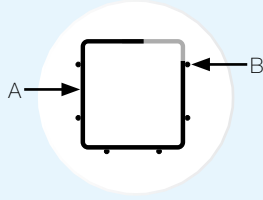

All measures in mm.  
 All measures are taken from the outer edges of the cable trays.  
 Width x height.  
 A & B = Wire diameter (Ø).

 1 pcs

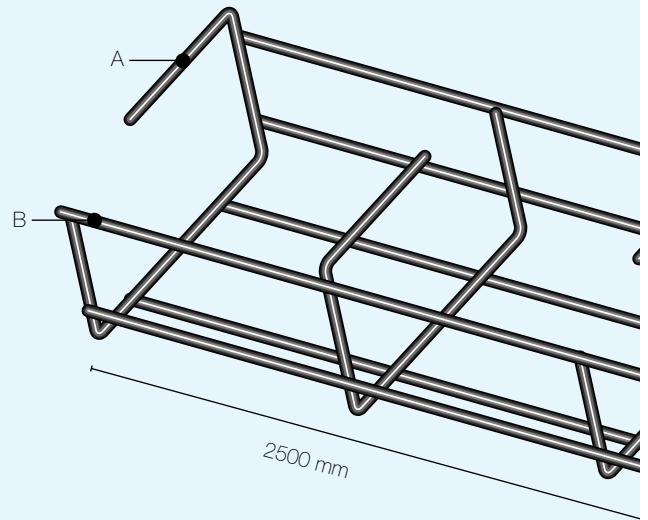

Cable Trays

### 42x42 L=2500mm | A = Ø 4, B = Ø 4

Material	Item No.	E-number
Zinc Plated Fzb	1140	1133057
Stainless 316L	1340	1133058
Stainless 304L	1440	1133059

 144 pcs / pallet

### 120x53 L=2500mm | A = Ø 4, B = Ø 4

Material	Item No.	E-number
Zinc Plated Fzb	1143	1133066
Stainless 316L	1343	1133067
Stainless 304L	1443	1133068

 72 pcs / pallet

### 53x53 L=2500mm | A = Ø 4, B = Ø 4

Material	Item No.	E-number
Zinc Plated Fzb	1141	1133060
Stainless 316L	1341	1133061
Stainless 304L	1441	1133062

 140 pcs / pallet

### 120x75 L=2500mm | A = Ø 5, B = Ø 5

Material	Item No.	E-number
Zinc Plated Fzb	1144	1133069
Stainless 316L	1344	1133070
Stainless 304L	1444	1133071

 72 pcs / pallet

### 75x75 L=2500mm | A = Ø 4, B = Ø 4

Material	Item No.	E-number
Zinc Plated Fzb	1142	1133063
Stainless 316L	1342	1133064
Stainless 304L	1442	1133065

 100 pcs / pallet

### 120x120 L=2500mm | A = Ø 5, B = Ø 5

Material	Item No.	E-number
Zinc Plated Fzb	1145	1133072
Stainless 316L	1345	1133073
Stainless 304L	1445	1133074

 42 pcs / pallet

# BRACKETS

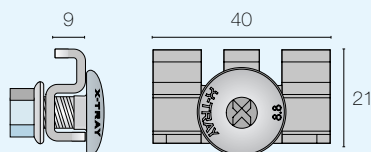
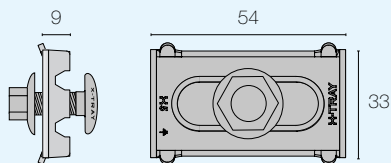
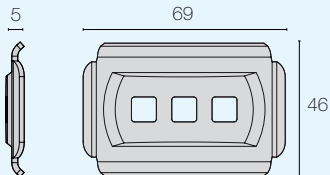
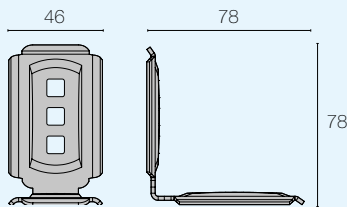
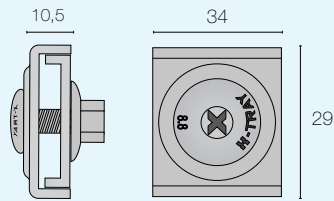
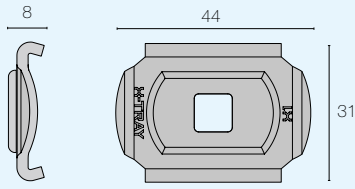

All measures are in mm.  
For more information about coatings,  
see page 3.

All accessories are sold by the unit, as well as in bags or cartons.  
(Unless otherwise stated)

## X1 Fitting (Page 46-47, 50-56, 60-62)

Material	Item No.	E-number	Bag	Carton
Zinc Plated Fzb	2101	1133211	40	320
Zinc/Nickel	2201	1133263		
Stainless 316L	2301	1133317		

## X2 Fitting, incl. bolts & nuts (Page 48-51)

Material	Item No.	E-number	Bag	Carton
Zinc Plated Fzb	2102	1133212	40	160
Zinc/Nickel	2202	1133264		
Stainless 316L	2302	1133318		

## X3 Angle Fitting (Page 47, 51-52)

Material	Item No.	E-number	Bag	Carton
Zinc Plated Fzb	2103	1133213	10	60
Zinc/Nickel	2203	1133265		
Stainless 316L	2303	1133319		

(For T-junctions and mounts)

## X4 Fitting (Page 46, 50, 52, 55, 61)

Material	Item No.	E-number	Bag	Carton
Zinc Plated Fzb	2104	1133214	40	160
Zinc/Nickel	2204	1133266		
Stainless 316L	2304	1133320		

## X5 Joining Fitting, 20-pack incl. bolts & nuts (Page 44-45)

Material	Item No.	E-number	Bag	Carton
Zinc Plated Fzb	2105	1133215	1	8
Zinc/Nickel	2205	1133267		
Stainless 316L	2305	1133321		

Used for X-Tray U-trays with 60 & 110 mm side, as well as C, G & Z (except 42x42)

## X5 Joining Fitting Mini, 20-pack incl. bolts & nuts (P. 44-45)

Material	Item No.	E-number	Bag	Carton
Zinc Plated Fzb	2105-2	1133026	1	8
Zinc/Nickel	2205-2	1133027		
Stainless 316L	2305-2	1133028		

Used for X-Tray U-trays with 30 mm low side, as well as Z-trays (except 42x42)

## X61 & X62 Bolts and nuts for all accessories, see page 25



All measures are in mm.  
For more information about coatings,  
see page 3.

All accessories are sold by the unit, as well as in bags or cartons.  
(Unless otherwise stated)

X 10 - Mounting for wall and pendant mounting M8 expansion bolt for walls and X6 & X62 M8 bolt and nut for pendants.

### X10 Bracket (Page 53)

Material	Item No.	E-number	Bag	Carton
Zinc Plated Fzb	2110-1	1133216	12	60
Hot Dip galv. Fzv	2210-1	1133268		
Stainless 316L	2310-1	1133322		

(For cable trays with 4 and 5 mm cable.)

### X10 Bracket Mini (Page 53)

Material	Item No.	E-number	Bag	Carton
Zinc Plated Fzb	2110-2	1133217	12	60
Hot Dip galv. Fzv	2210-2	1133269		
Stainless 316L	2310-2	1133323		

(For cable trays with 4mm cable.)

### X10 Bracket 50 (Page 53)

Material	Item No.	E-number	Bag	Carton
Zinc Plated Fzb	2110-3	1133588	12	60
Hot Dip galv. Fzv	2210-3	1133589		
Stainless 316L	2310-3	1133590		

(For cable trays with 4 and 5 mm cable.)

### X10 Bracket Mini 50 (Page 53)

Material	Item No.	E-number	Bag	Carton
Zinc Plated Fzb	2110-4	1133591	12	60
Hot Dip galv. Fzv	2210-4	1133592		
Stainless 316L	2310-4	1133593		

(For cable trays with 4mm cable.)

### X10 Bracket 100 (Page 53)

Material	Item No.	E-number	Bag	Carton
Zinc Plated Fzb	2110-5	1133594	12	60
Hot Dip galv. Fzv	2210-5	1133595		
Stainless 316L	2310-5	1133596		

(For cable trays with 4 and 5 mm cable.)

### X10 Bracket Low Side (Page 53)

Material	Item No.	E-number	Bag	Carton
Zinc Plated Fzb	2110-6	1133597	12	60
Zink/Nickel	2210-6	1133598		
Stainless 316L	2310-6	1133599		

For cable trays with 30 mm low side - 60 & 120 wide.

**X61 & X62** Bolts and nuts for all accessories, see page 25

# MOUNTING

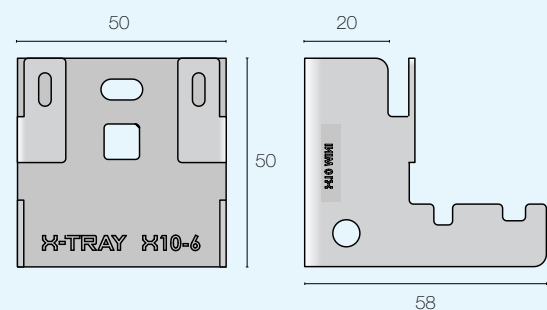
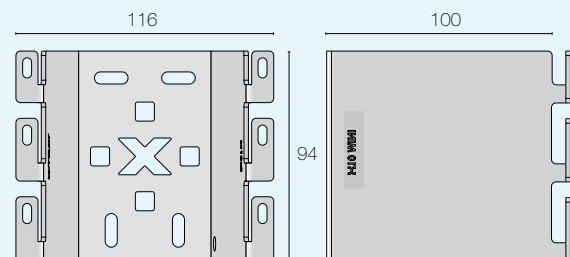
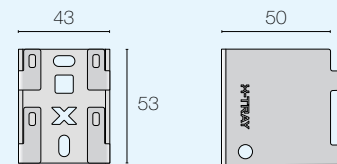
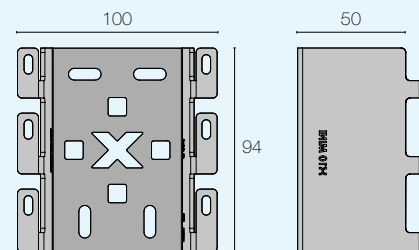
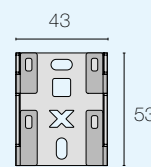
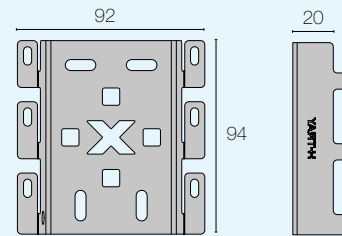

# MOUNTING

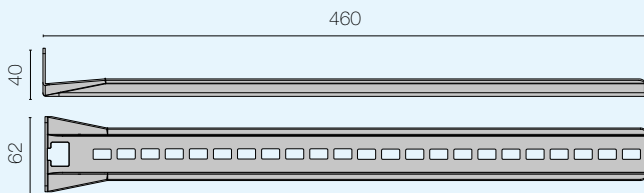
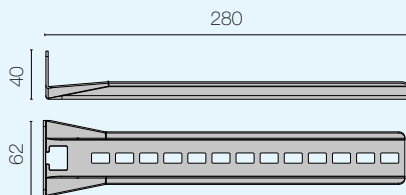
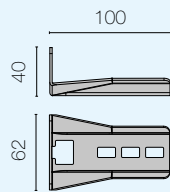
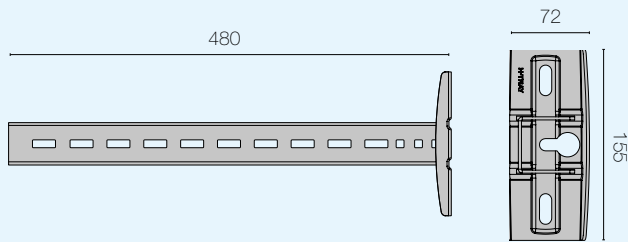
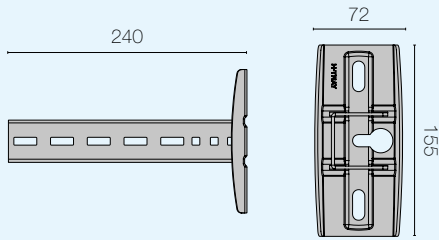

All measures are in mm.  
For more information about coatings,  
see page 3.

All accessories are sold by the unit, as well as in bags or cartons.  
(unless otherwise stated)

## X11 Pendant Premium 240 (Page 56-57, 59-61)

Material	Item No.	E-number	Carton
Zinc Plated Fzb	2111-240	1133218	8
Zinc/Nickel	2211-240	1133270	
Stainless 316L	2311-240	1133324	

For heavier installations. Assembled with M8/M10 bolt. As an extension, use X50 U-Bar. Also available as flexible, X12 see page 20.

## X11 Pendant Premium 480 (Page 56-57, 59-61)

Material	Item No.	E-number	Carton
Zinc Plated Fzb	2111-480	1133219	8
Zinc/Nickel	2211-480	1133271	
Stainless 316L	2311-480	1133325	

For heavier installations. Assembled with M8/M10 bolt. As an extension, use X50 U-Bar. Also available as flexible, X12 see page 20.

## X14 Pendant 100 (Page 54-56)

Material	Item No.	E-number	Carton
Zinc Plated Fzb	2114-100	1133223	16
Hot Dip galv. Fzv	2214-100	1133275	
Stainless 316L	2314-100	1133329	

Pendant for lighter installations.

## X14 Pendant 280 (Page 54-56)

Material	Item No.	E-number	Carton
Zinc Plated Fzb	2114-280	1133224	16
Hot Dip galv. Fzv	2214-280	1133276	
Stainless 316L	2314-280	1133330	

Pendant for lighter installations.

## X14 Pendant 460 (Page 54-56)

Material	Item No.	E-number	Carton
Zinc Plated Fzb	2114-460	1133225	16
Hot Dip galv. Fzv	2214-460	1133277	
Stainless 316L	2314-460	1133331	

Pendant for lighter installations.

**X61 & X62** Bolts and nuts for all accessories, see page 25

All measures are in mm.  
For more information about coatings,  
see page 3.

All accessories are sold by the unit, as well as in bags or cartons.  
(unless otherwise stated)

Cantilever for wall and pendant mounting M8/M10 expansion bolt for walls and X61 & X62 M8 bolt and nut for pendants.

### X15 Cantilever 60-120 (Page 52, 54, 56-57)

Material	Item No.	E-number	Carton
Zinc Plated Fzb	2115-120	1133226	10
Hot Dip galv. Fzv	2215-120	1133278	
Stainless 316L	2315-120	1133332	

### X15 Cantilever 220 (Page 52, 54, 56-57)

Material	Item No.	E-number	Carton
Zinc Plated Fzb	2115-220	1133227	10
Hot Dip galv. Fzv	2215-220	1133279	
Stainless 316L	2315-220	1133333	

### X15 Cantilever 320 (Page 52, 54, 56-57)

Material	Item No.	E-number	Carton
Zinc Plated Fzb	2115-320	1133228	10
Hot Dip galv. Fzv	2215-320	1133280	
Stainless 316L	2315-320	1133334	

### X15 Cantilever 420 (Page 52, 54, 56-57)

Material	Item No.	E-number	Carton
Zinc Plated Fzb	2115-420	1133229	10
Hot Dip galv. Fzv	2215-420	1133281	
Stainless 316L	2315-420	1133335	

### X15 Cantilever 520 (Page 52, 54, 56-57)

Material	Item No.	E-number	Carton
Zinc Plated Fzb	2115-520	1133230	6
Hot Dip galv. Fzv	2215-520	1133282	
Stainless 316L	2315-520	1133336	

### X15 Cantilever 620 (Page 52, 54, 56-57)

Material	Item No.	E-number	Carton
Zinc Plated Fzb	2115-620	1133231	6
Hot Dip galv. Fzv	2215-620	1133283	
Stainless 316L	2315-620	1133337	

X61 & X62 Bolts and nuts for all accessories, see page 25

# MOUNTING

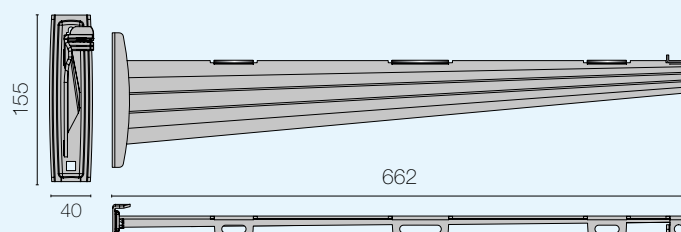
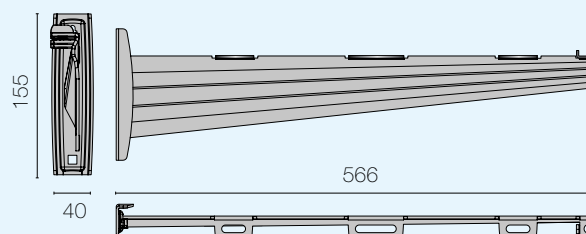
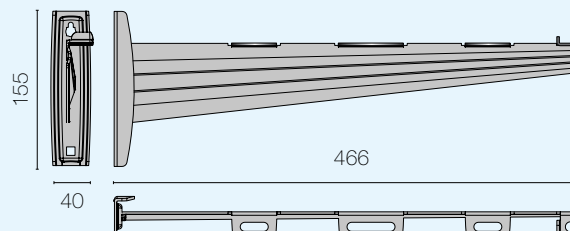
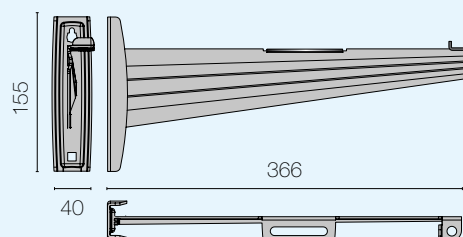
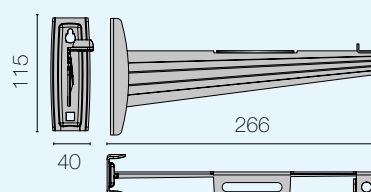
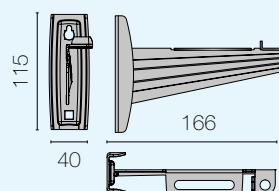

# MOUNTING

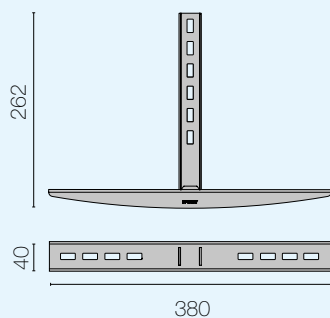
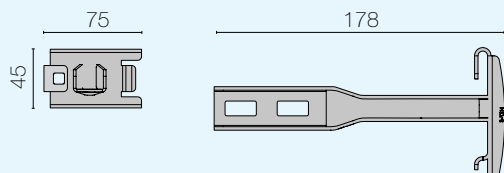
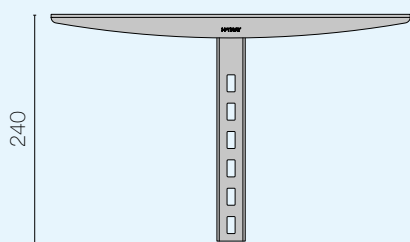
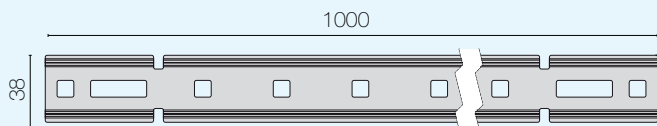
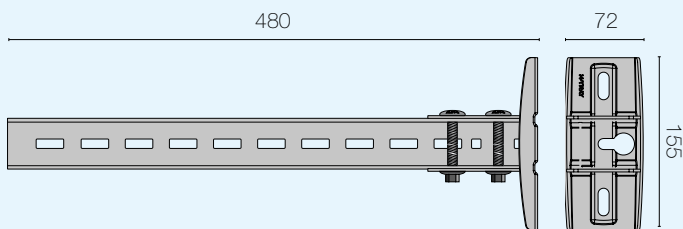
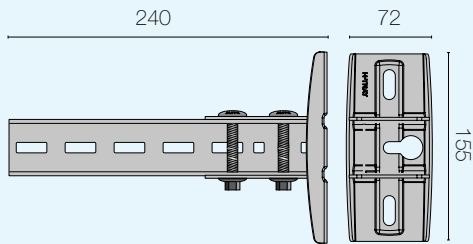

All measures are in mm.  
For more information about coatings,  
see page 3.

All accessories are sold by the unit, as well as in bags or cartons.  
(unless otherwise stated)

## X12 Pendant Flexible 240 (Page 59-60)

Material	Item No.	E-number	Carton
Zinc Plated Fzb	2112-240	1133220	4
Zinc/Nickel	2212-240	1133272	
Stainless 316L	2312-240	1133326	

Adjustable ceiling mount 45°. Assembled with M8/M10 bolt.  
As an extension, use X50 U-Bar.

## X12 Pendant Flexible 480 (Page 59-60)

Material	Item No.	E-number	Carton
Zinc Plated Fzb	2112-480	1133221	4
Zinc/Nickel	2212-480	1133273	
Stainless 316L	2312-480	1133327	

Adjustable ceiling mount 45°. Assembled with M8/M10 bolt.  
As an extension, use X50 U-Bar.

## X13 Side Support (Page 59)

Material	Item No.	E-number	Carton
Zinc Plated Fzb	2113	1133222	8
Hot Dip galv. Fzv	2213	1133274	
Stainless 316L	2313	1133328	

Increases the stability of the pendant.

## X16 Floor Support (Page 60-61)

Material	Item No.	E-number	Carton
Zinc Plated Fzb	2116	1133232	8
Hot Dip galv. Fzv	2216	1133284	
Stainless 316L	2316	1133338	

## X17 Support Hook 120-320 (Page 54, 56-57, 60)

Material	Item No.	E-number	Bag  / Carton
Zinc Plated Fzb	2117	1133233	8 / 16
Hot galv. Fzv	2217	1133285	
Stainless 316L	2317	1133339	

Support Hook for X-Tray 120-320 mm.

## X18 Support Hook 420-620 (Page 54, 56-57, 59-60)

Material	Item No.	E-number	Carton
Zinc Plated Fzb	2118	1133234	8
Hot Dip galv. Fzv	2218	1133286	
Stainless 316L	2318	1133340	

Support Hook for X-Tray 420-620 mm.

**X61 & X62** Bolts and nuts for all accessories, see page 25



All measures are in mm.  
For more information about coatings,  
see page 3.

All accessories are sold by the unit, as well as in bags or cartons.  
(unless otherwise stated)

For lightweight installations For heavier installations, place the  
cantilevers closer together, or use an X15 Cantilever.

### X15 Low Cantilever 60-120 (Page 53)

Material	Item No.	E-number	Carton
Zinc Plated Fzb	2119-120	1133099	10
Hot Dip galv. Fzv	2219-120	1133379	
Stainless 316L	2319-120	1133380	

Max load 50 kg.

### X19 Low Cantilever 220 (Page 53)

Material	Item No.	E-number	Carton
Zinc Plated Fzb	2119-220	1133545	10
Hot Dip galv. Fzv	2219-220	1133546	
Stainless 316L	2319-220	1133547	

Max load 50 kg.

### X19 Low Cantilever 320 (Page 53)

Material	Item No.	E-number	Carton
Zinc Plated Fzb	2119-320	1133548	10
Hot Dip galv. Fzv	2219-320	1133549	
Stainless 316L	2319-320	1133550	

Max load 40 kg.

### X19 Low Cantilever 420 (Page 53)

Material	Item No.	E-number	Carton
Zinc Plated Fzb	2119-420	1133551	10
Hot Dip galv. Fzv	2219-420	1133552	
Stainless 316L	2319-420	1133553	

Max load 35 kg.

### X19 Low Cantilever 520 (Page 53)

Material	Item No.	E-number	Carton
Zinc Plated Fzb	2119-520	1133554	6
Hot Dip galv. Fzv	2219-520	1133555	
Stainless 316L	2319-520	1133556	

Max load 30 kg.

### X19 Low Cantilever 620 (Page 53)

Material	Item No.	E-number	Carton
Zinc Plated Fzb	2119-620	1133557	6
Hot Dip galv. Fzv	2219-620	1133558	
Stainless 316L	2319-620	1133559	

Max load 30 kg.

**X61 & X62** Bolts and nuts for all accessories, see page 25

# MOUNTING

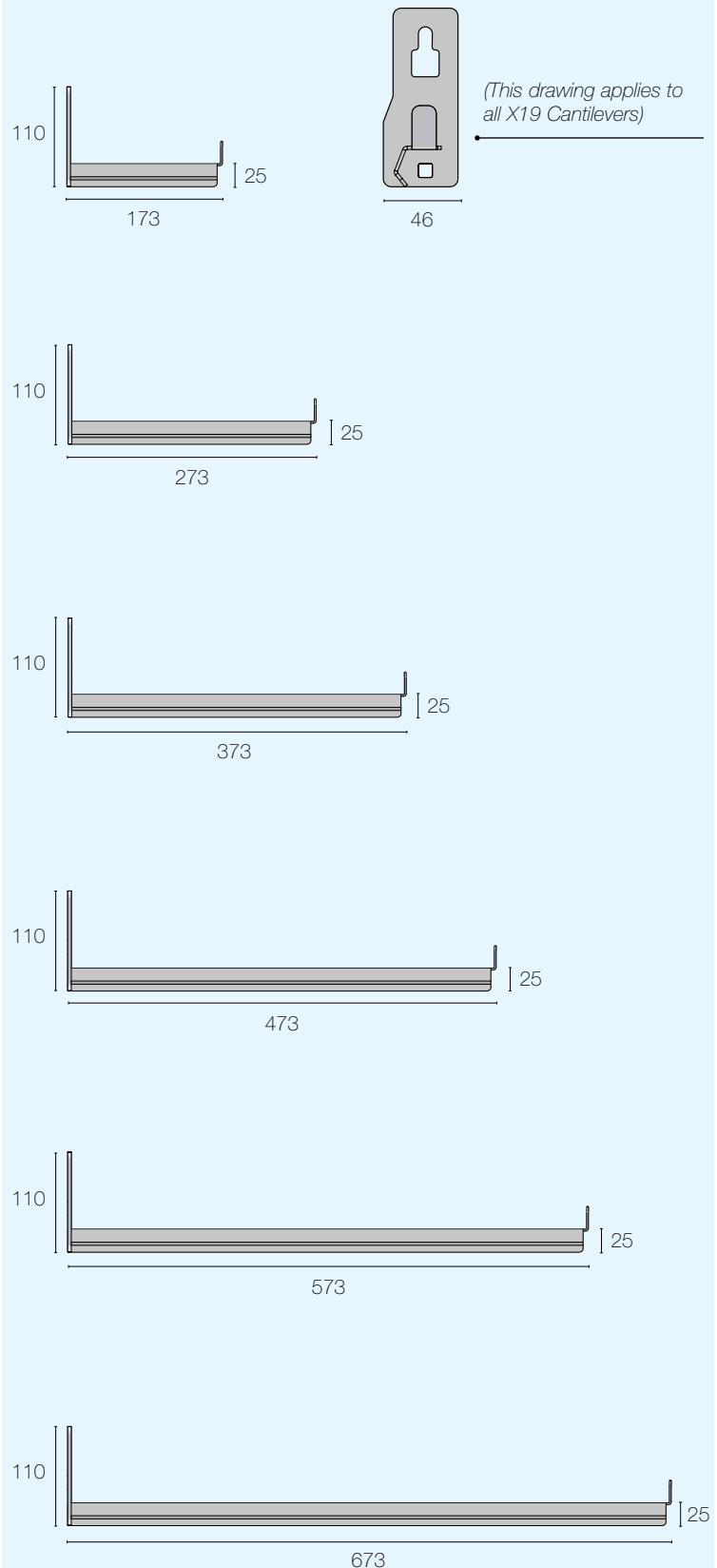

Accessories

# THREADED ROD

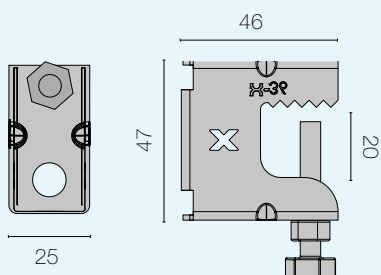
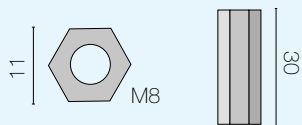
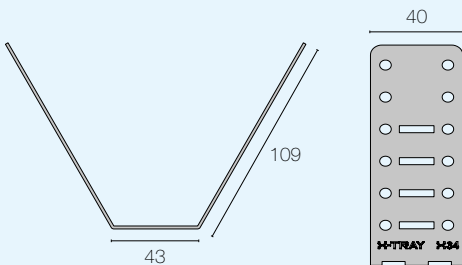
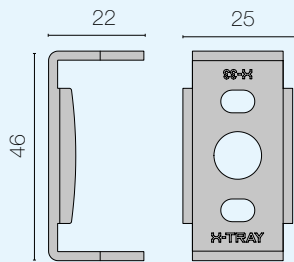
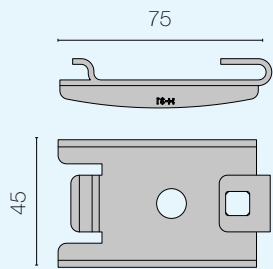
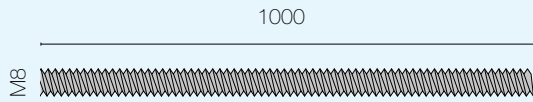

All measures are in mm.  
For more information about coatings,  
see page 3.

All accessories are sold by the unit, as well as in bags or cartons.  
(unless otherwise stated)

## X30 Threaded Rod M8x1000 (Page 57, 61-62)

Material	Item No.	E-number	Carton
Zinc Plated Fzb	2130	1133235	10
Zinc/Nickel	2230	1133287	
Stainless 316L	2330	1133341	

For other lengths, ask us.

## X31 Threaded Rod Support Hook (Page 61)

Material	Item No.	E-number	Bag	Carton
Zinc Plated Fzb	2131	1133236	10	60
Zinc/Nickel	2231	1133288		
Stainless 316L	2331	1133342		

For X-Tray 120-220 mm.

## X33 Threaded Rod Adapter (Page 61)

Material	Item No.	E-number	Bag	Carton
Zinc Plated Fzb	2133	1133237	10	100
Zinc/Nickel	2233	1133289		
Stainless 316L	2333	1133343		

For installation of Threaded Rod.

## X34 Ceiling Fitting (Page 62)

Material	Item No.	E-number	Carton
Senzimir	2234	1132928	60

Possible to adjust according to the angle of the ceiling.

## X35 Threaded Rod Distance Nut, 10-pack (Page 62)

Material	Item No.	E-number	Bag	Carton
Zinc Plated Fzb	2135	1133238	1	10
Zinc/Nickel	2235	1133290		
Stainless 316L	2335	1133344		

Used to extend Threaded Rods.

## X36 Beam Clamp (Page 62)

Material	Item No.	E-number	Bag	Carton
Zinc/Nickel	2236	1133291	10	40

For installation of Threaded Rods or suspension of Hable trays.

## X61 & X62 Bolts and nuts for all accessories, see page 25

All measures are in mm.  
For more information about coatings,  
see page 3.

All accessories are sold by the unit, as well as in bags or cartons.  
(unless otherwise stated)



### X50 U-Bar 400-3000 mm (Page 57-61)

Material	Item No.	E-number	Length:
Zinc Plated Fzb	2150-400	1133239	400
Zinc/Nickel	2250-400	1133292	400
Stainless 316L	2350-400	1133345	400
Zinc Plated Fzb	2150-520	1133240	520
Zinc Plated Fzb	2150-600	1133241	600
Zinc/Nickel	2250-600	1133293	600
Stainless 316L	2350-600	1133346	600
Zinc Plated Fzb	2150-720	1133242	720
Zinc Plated Fzb	2150-800	1133243	800
Zinc/Nickel	2250-800	1133294	800
Stainless 316L	2350-800	1133347	800
Zinc Plated Fzb	2150-920	1133244	920
Zinc Plated Fzb	2150-1000	1133245	1000
Zinc/Nickel	2250-1000	1133295	1000
Stainless 316L	2350-1000	1133348	1000
Zinc Plated Fzb	2150-1920	1133246	1920*
Zinc Plated Fzb	2150-2120	1133247	2120*
Zinc Plated Fzb	2150-2480	1133248	2480*
Zinc Plated Fzb	2150-3000	1133249	3000*

 \* 72 pcs / pallet



Used as an extension to X11/X12 Pendants. Or separately in order to build structures. Also used to built X-Rack.

### X51 U-Bar Joining Fitting (Page 58)

Material	Item No.	E-number	Bag  / Carton 
Zinc Plated Fzb	2151	1133250	8 / 16
Zinc/Nickel	2251	1133296	
Stainless 316L	2351	1133349	

Used to extend U-bars.

### X52 U-Bar Corner Fitting (Page 58-59)

Material	Item No.	E-number	Bag  / Carton 
Zinc Plated Fzb	2152	1133251	8 / 32
Zinc/Nickel	2252	1133297	
Stainless 316L	2352	1133350	

Used to install U-bars.

**X61 & X62** Bolts and nuts for all accessories, see page 25

# U-BAR

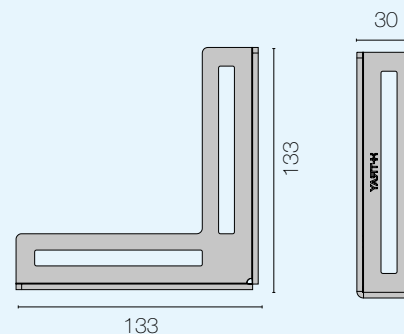
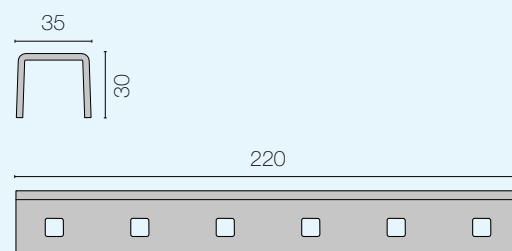
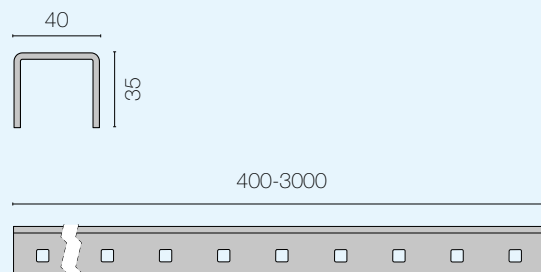

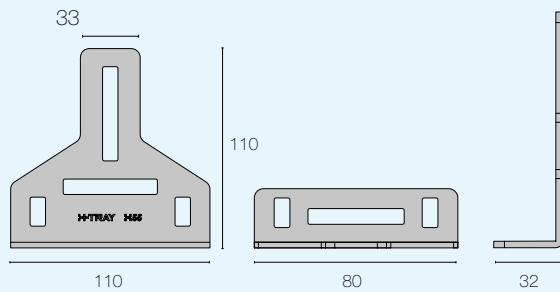
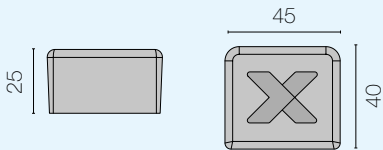
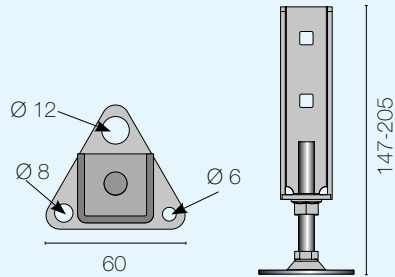

# U-BAR



All measures are in mm.  
For more information about coatings,  
see page 3.



All accessories are sold by the unit, as well as in bags or cartons.  
(unless otherwise stated)

## X53 U-Bar Adjustable Foot (Page 59)

Material	Item No.	E-number	Bag  /	Carton 
Zinc Plated Fzb	2153	1133252	8	16
Zinc/Nickel	2253	1133298		

The adjustable foot is used to compensate for the difference in height on uneven floors.

## X54 U-Bar End Cap

Material	Item No.	E-number	Bag  /	Carton 
Black plastic	2554	1133369	10	80

Safety guard for U-bar ends.

## X55 U-Bar Angle Fitting (Page 59)

Material	Item No.	E-number	Carton 
Zinc Plated Fzb	2155	1132916	30
Zinc/Nickel	2255	1132917	
Stainless 316L	2355	1132918	

Used to install U-bars.

## X61 & X62 Bolts and nuts for all accessories, see page 25

# ACCESSORIES

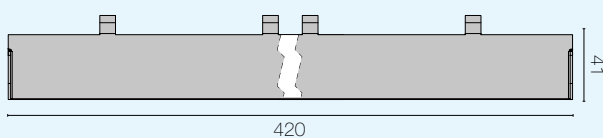
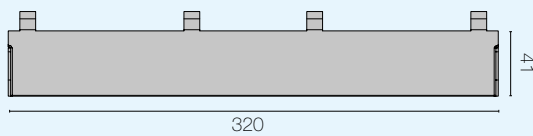
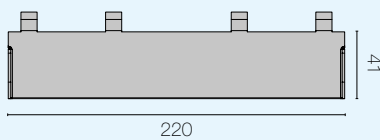
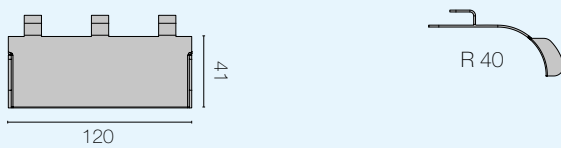

## X60 Radius Limiter 120 (Page 64)

Material	Item No.	E-number	Carton 
Zinc Plated Fzb	2160-120	1133253	8

Reduces bending radius for sensitive cables. Can be combined for greater width.

## X60 Radius Limiter 220 (Page 64)

Material	Item No.	E-number	Carton 
Zinc Plated Fzb	2160-220	1133254	8

Reduces bending radius for sensitive cables. Can be combined for greater width.

## X60 Radius Limiter 320 (Page 64)

Material	Item No.	E-number	Carton 
Zinc Plated Fzb	2160-320	1133255	8

Reduces bending radius for sensitive cables. Can be combined for greater width.

## X60 Radius Limiter 420 (Page 64)



Material	Item No.	E-number	Carton 
Zinc Plated Fzb	2160-420	1133256	8

Reduces bending radius for sensitive cables. Can be combined for greater width.



All measures are in mm.  
For more information about coatings,  
see page 3.

All accessories are sold by the unit, as well as in bags or cartons.  
(unless otherwise stated)

**X61** Carriage Bolt M8x27, 40 pack (Page 44-47, 50-62)

Material	Item No.	E-number	Bag  /	Carton 
Zinc Plated Fzb	2161	1133257	1	10
Zinc/Nickel	2261	1133299		
Stainless 316L	2361	1133351		

**X62** Distance Nut M8, 40 pack (Page 44-47, 50-62)

Material	Item No.	E-number	Bag  /	Carton 
Zinc Plated Fzb	2162	1133258	1	10
Zinc/Nickel	2262	1133300		
Stainless 316L	2362	1133352		

# ACCESSORIES

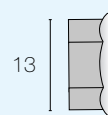
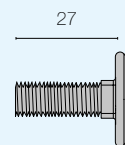

# ACCESSORIES

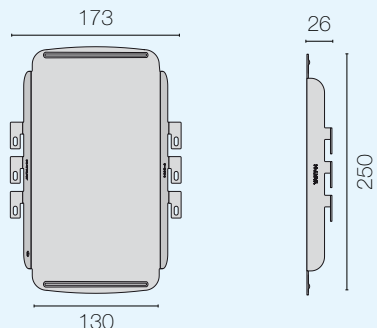
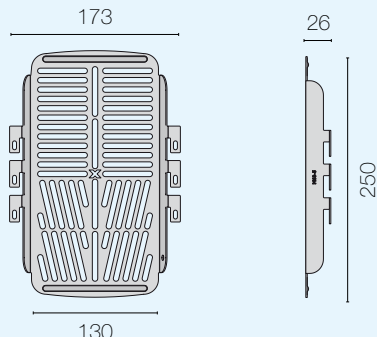
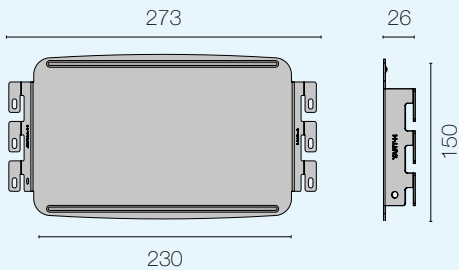
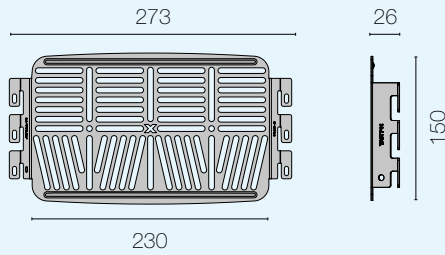
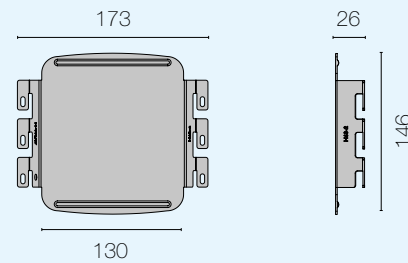
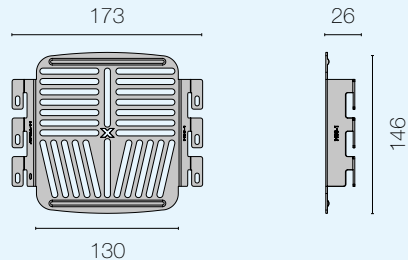



26

All measures are in mm.  
For more information about coatings,  
see page 3.



All accessories are sold by the unit, as well as in bags or cartons.  
(unless otherwise stated)

## X63 Accessories Holder (Page 63)

Material	Item No.	E-number	Bag  / Carton 
Zinc Plated Fzb	2163-1	1133259	5 / 30
Hot Dip galv. Fzv	2263-1	1133301	
Stainless 316L	2363-1	1133353	



Attachment for accessories, with hole.

## X63 Accessories Holder without hole (Page 63)

Material	Item No.	E-number	Bag  / Carton 
Zinc Plated Fzb	2163-2	1133260	5 / 30
Hot Dip galv. Fzv	2263-2	1133302	
Stainless 316L	2363-2	1133354	



Attachment for accessories, without hole.

## X63 Accessories Holder Wide (Page 63)

Material	Item No.	E-number	Bag  / Carton 
Zinc Plated Fzb	2163-3	1133572	5 / 30
Hot Dip galv. Fzv	2263-3	1133573	
Stainless 316L	2363-3	1133574	



Attachment for accessories, with hole.

## X63 Accessories Holder Wide without hole (Page 63)

Material	Item No.	E-number	Bag  / Carton 
Zinc Plated Fzb	2163-4	1133576	5 / 30
Hot Dip galv. Fzv	2263-4	1133577	
Stainless 316L	2363-4	1133578	



Attachment for accessories, without hole.

## X63 Accessories Holder High (Page 63)

Material	Item No.	E-number	Bag  / Carton 
Zinc Plated Fzb	2163-5	1133580	5 / 30
Hot Dip galv. Fzv	2263-5	1133581	
Stainless 316L	2363-5	1133582	

Attachment for accessories, with hole.

## X63 Accessories Holder High without hole (Page 63)

Material	Item No.	E-number	Bag  / Carton 
Zinc Plated Fzb	2163-6	1133584	5 / 30
Hot Dip galv. Fzv	2263-6	1133585	
Stainless 316L	2363-6	1133586	



Attachment for accessories, without hole.



All measures are in mm.  
For more information about coatings,  
see page 3.



All accessories are sold by the unit, as well as in bags or cartons.  
(unless otherwise stated)

### X63 Accessories Holder Mini (Page 63)

Material	Item No.	E-number	Bag  / Carton 
Zinc Plated Fzb	2163-7	1133601	5 / 30
Hot Dip galv. Fzv	2263-7	1133602	
Stainless 316L	2363-7	1133603	



Attachment for accessories, with hole.

### X63 Accessories Holder Mini without hole (Page 63)

Material	Item No.	E-number	Bag  / Carton 
Zinc Plated Fzb	2163-8	1133605	5 / 30
Hot Dip galv. Fzv	2263-8	1133606	
Stainless 316L	2363-8	1133607	



Attachment for accessories, without hole.

### X80 Side Accessories Holder (Page 63)

Material	Item No.	E-number	Bag  / Carton 
Zinc Plated Fzb	2180-1	1132920	5 / 30
Hot Dip galv. Fzv	2280-1	1132921	
Stainless 316L	2380-1	1132922	



Attachment for accessories, with hole. For all cable trays except Z-trays. Extra handy on vertical trays.

### X80 Side Accessories Holder without hole (Page 63)

Material	Item No.	E-number	Bag  / Carton 
Zinc Plated Fzb	2180-2	1132924	5 / 30
Hot Dip galv. Fzv	2280-2	1132925	
Stainless 316L	2380-2	1132926	



Attachment for accessories, without hole. For all cable trays except Z-trays. Extra handy on vertical trays.

### X80 Side Accessories Holder High (Page 63)

Material	Item No.	E-number	Bag  / Carton 
Zinc Plated Fzb	2180-3	1133564	5 / 30
Hot Dip galv. Fzv	2280-3	1133565	
Stainless 316L	2380-3	1133566	

Attachment for accessories, with hole. For all cable trays except Z-trays. Extra handy on vertical trays.

### X80 Side Accessories Holder High without hole (Page 63)

Material	Item No.	E-number	Bag  / Carton 
Zinc Plated Fzb	2180-4	1133568	5 / 30
Hot Dip galv. Fzv	2280-4	1133569	
Stainless 316L	2380-4	1133570	

Attachment for accessories, without hole. For all cable trays. Extra handy on vertical trays.

# ACCESSORIES

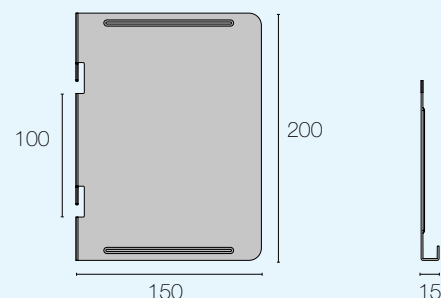
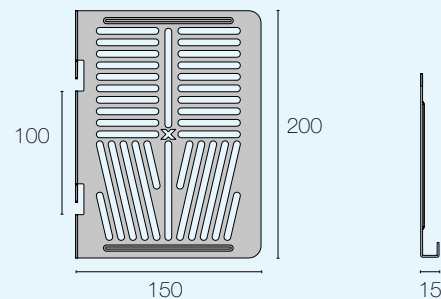
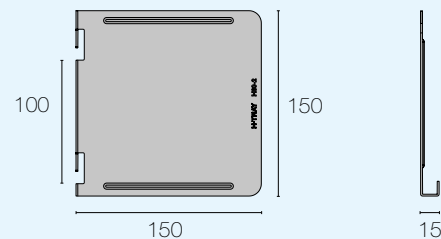
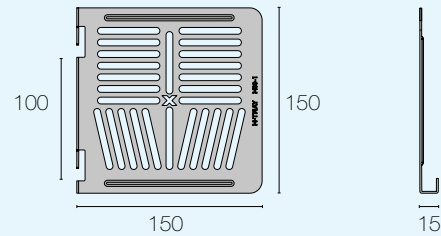
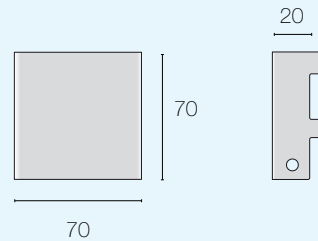
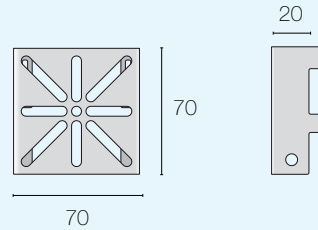

# ACCESSORIES

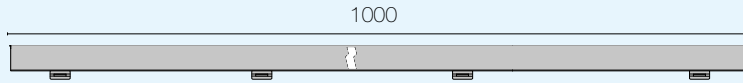

All measures are in mm.  
For more information about coatings,  
see page 3.

All accessories are sold by the unit, as well as in bags or cartons.  
(unless otherwise stated)

## X65 Cover 53 (Page 65)

Material	Item No.	E-number
Sendzimir Fzs	2265-53	1133305
Stainless 316L	2365-53	1133357

## X65 Cover 60

Material	Item No.	E-number
Sendzimir Fzs	2265-60	1133306
Stainless 316L	2365-60	1133358

## X65 Cover 75

Material	Item No.	E-number
Sendzimir Fzs	2265-75	1133307
Stainless 316L	2365-75	1133359

## X65 Cover 100

Material	Item No.	E-number
Sendzimir Fzs	2265-100	1133476
Stainless 316L	2365-100	1133480

## X65 Cover 120

Material	Item No.	E-number
Sendzimir Fzs	2265-120	1133308
Stainless 316L	2365-120	1133360

## X65 Cover 150

Material	Item No.	E-number
Sendzimir Fzs	2265-150	1133477
Stainless 316L	2365-150	1133481

## X65 Cover 220

Material	Item No.	E-number
Sendzimir Fzs	2265-220	1133309
Stainless 316L	2365-220	1133361

## X65 Cover 320

Material	Item No.	E-number
Sendzimir Fzs	2265-320	1133310
Stainless 316L	2365-320	1133362

## X65 Cover 420

Material	Item No.	E-number
Sendzimir Fzs	2265-420	1133311
Stainless 316L	2365-420	1133363

## X65 Cover 520

Material	Item No.	E-number
Sendzimir Fzs	2265-520	1133312
Stainless 316L	2365-520	1133364

## X65 Cover 620

Material	Item No.	E-number
Sendzimir Fzs	2265-620	1133313
Stainless 316L	2365-620	1133365

All measures are in mm.  
For more information about coatings,  
see page 3.

All accessories are sold by the unit, as well as in bags or cartons.  
(unless otherwise stated)

### X64 L-Divider 45 mm (Page 66)

Material	Item No.	E-number
Sendzimir Fzs	2264-45	1133303
Stainless 316L	2364-45	1133355

### X64 L-Divider 95 mm (Page 66)

Material	Item No.	E-number
Sendzimir Fzs	2264-95	1133304
Stainless 316L	2364-95	1133356

 300 pcs / pallet

### X66 Divider Flexible 45 mm (Page 66)

Material	Item No.	E-number
Sendzimir Fzs	2266-45	1133314
Stainless 316L	2366-45	1133366



### X66 Divider Flexible 95 mm (Page 66)

Material	Item No.	E-number
Sendzimir Fzs	2266-95	1133315
Stainless 316L	2366-95	1133367

 400 pcs / pallet



For use together with X67. Flexible and pliable.

### X67 Divider Clamp for Divider Flexible (Page 66)

Material	Item No.	E-number	Bag  / Carton 
Sendzimir Fzs	2267	1133316	20 / 160
Stainless 316L	2367	1133368	

For use together with X66. Installation distance cc 50 cm.



### X68 Equipotential Bonding Screw (Page 65)

Material	Item No.	E-number	Bag  / Carton 
Brass	2568	1133370	10 / 100

Nickel-coated. For cables up to 25 mm<sup>2</sup>; however, only 16 mm<sup>2</sup> cables in the hole.

For more information about the equipotential bonding, see page 67 or go to [axelent.com](http://axelent.com).

### X68 Earth Screw (Page 65)

Material	Item No.	E-number	Bag  / Carton 
Brass	2568-1	1133371	10 / 100

Nickel-coated. For cables up to 25 mm<sup>2</sup>.

For more information about the equipotential bonding, see page 67 or go to [axelent.com](http://axelent.com).

### X69 Side Radius Limiter (Page 65)

Material	Item No.	E-number	Carton 
Zinc Plated Fzb	2169	1132932	10

Reduces bending radius for sensitive cables.

# ACCESSORIES

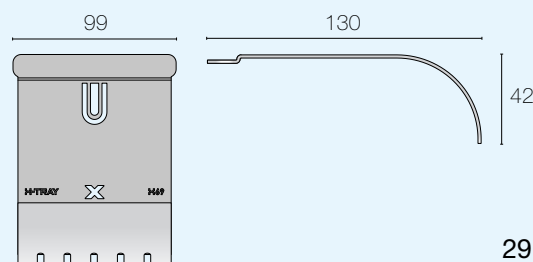
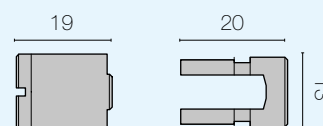
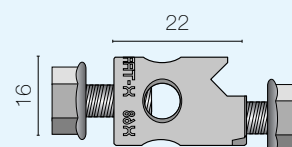
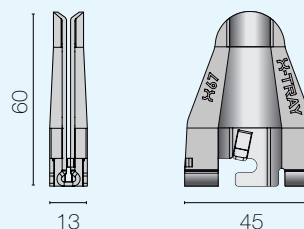
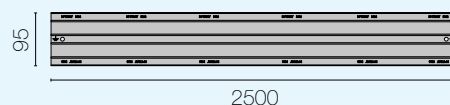
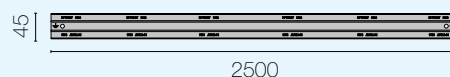
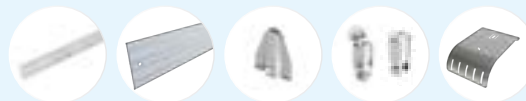

# ACCESSORIES

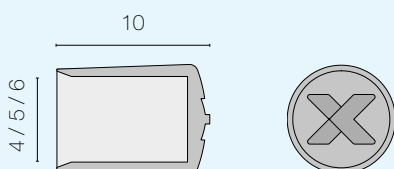
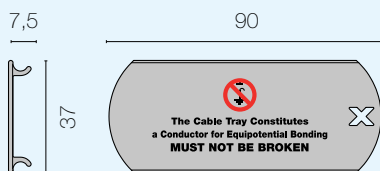
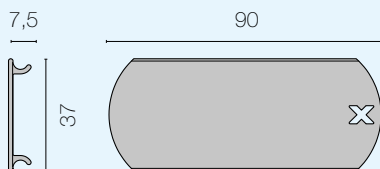
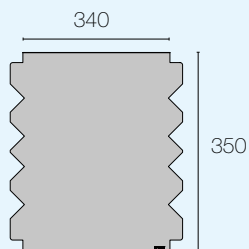
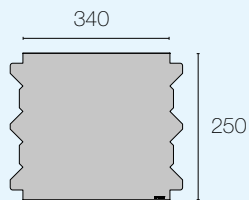
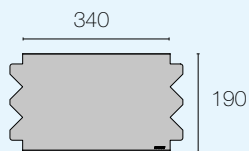
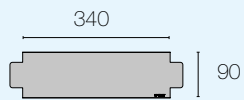

All measures are in mm.  
For more information about coatings,  
see page 3.

All accessories are sold by the unit, as well as in bags or cartons.  
(unless otherwise stated)

## X81 Bending Plate 120 (Page 63)

Material	Item no.	E-number	Carton
Aluminium	2581-120	1133531	10

## X81 Bending Plate 220 (Page 63)

Material	Item no.	E-number	Carton
Aluminium	2581-220	1133532	10

## X81 Bending Plate 320 (Page 63)

Material	Item no.	E-number	Carton
Aluminium	2581-320	1133533	10

## X81 Bending Plate 420 (Page 63)

Material	Item no.	E-number	Carton
Aluminium	2581-420	1133534	10

## X70 Marking Clip (Page 63)

Material	Item no.	E-number	Bag	Carton
White plastic	2570-01	1133372	10	100

Plastic, halogen-free. Available with your choice of print for an additional cost.

## X70 Marking Clip Equipotential Bonding (Page 63)

Material	Item no.	E-number	Bag	Carton
Swedish	2570-02	1133373	10	100
English	2570-03	1133374		
German	2570-04	1133375		

Plastic, halogen-free.

## X72 Safety Cap, 100 pack (Page 50-51, 63)

Material	Item no.	E-number	Carton
Black plastic Ø 4 mm	2572-4	1133376	10
Black plastic Ø 4 mm	2572-5	1133377	
Black plastic Ø 6 mm	2572-6	1133378	

Safety guard against sharp edges. Halogen-free.

All measures are in mm.  
For more information about coatings,  
see page 3.

# TOOLS

All accessories are sold by the unit, as well as in bags or cartons.  
(unless otherwise stated)

## X75 Bolt Cutter (Page 48-51)

Material	Item no.	E-number
Chrome Molybdenum	2575	1660847

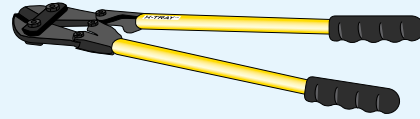

## X76 13 mm Spanner

Material	Item no.	E-number
Chrome Vanadium	2576	1660848

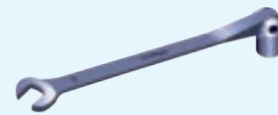

## X77 Wire Cutting Machine (incl. battery, charger & bag)

Material	Item no.	E-number
Wire cutting machine - Battery operated	2577	1639942
Battery Bosch Li-Ion 18V/2.0 Ah	2577-1	1639943
Spare blade kit	2577-2	1639944



# X-TRAY® ADDITIONAL LAYER

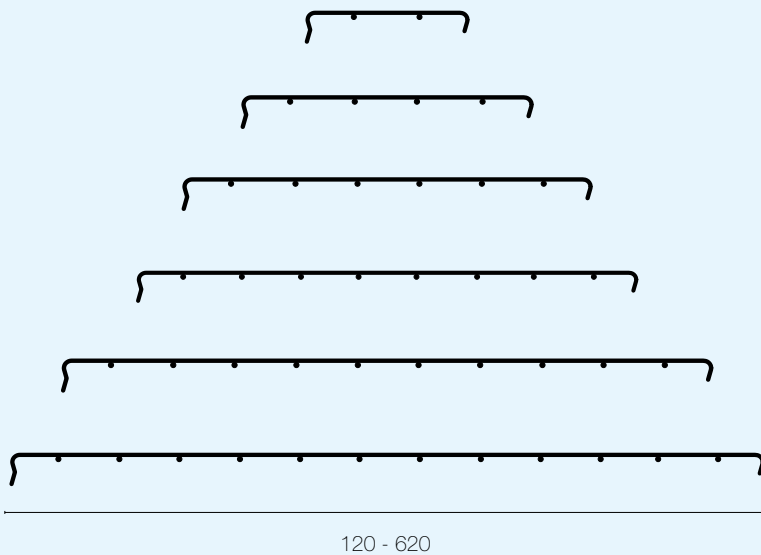
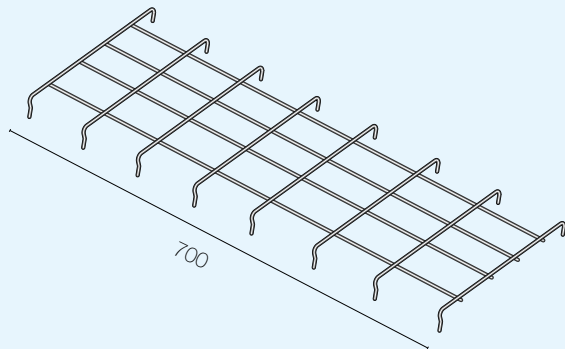

All measures are in mm.  
For more information about coatings,  
see page 3.

All accessories are sold by the unit, as well as in bags or cartons.  
*(unless otherwise stated)*

## X-Tray Additional Layer 120x700

Material	Item no.	E-number
Zinc Plated Fzb	4199-079	1133075
Hot Dip galv. Fzv	4299-079	1133076
Stainless 316L	4399-079	1133077
Stainless 304L	4499-079	1133078

## X-Tray Additional Layer 220x700

Material	Item no.	E-number
Zinc Plated Fzb	4199-080	1133079
Hot Dip galv. Fzb	4299-080	1133080
Stainless 316L	4399-080	1133081
Stainless 304L	4499-080	1133082

## X-Tray Additional Layer 320x700

Material	Item no.	E-number
Zinc Plated Fzb	4199-081	1133083
Hot Dip galv. Fzb	4299-081	1133084
Stainless 316L	4399-081	1133085
Stainless 304L	4499-081	1133086

## X-Tray Additional Layer 420x700

Material	Item no.	E-number
Zinc Plated Fzb	4199-082	1133087
Hot Dip galv. Fzb	4299-082	1133088
Stainless 316L	4399-082	1133089
Stainless 304L	4499-082	1133090

## X-Tray Additional Layer 520x700

Material	Item no.	E-number
Zinc Plated Fzb	4199-083	1133091
Hot Dip galv. Fzb	4299-083	1133092
Stainless 316L	4399-083	1133093
Stainless 304L	4499-083	1133094

## X-Tray Additional Layer 620x700

Material	Item no.	E-number
Zinc Plated Fzb	4199-084	1133095
Hot Dip galv. Fzb	4299-084	1133096
Stainless 316L	4399-084	1133097
Stainless 304L	4499-084	1133098

Used for an extra layer of cables / lock cables in place /  
protective lock.



All measures are in mm.  
For more information about coatings,  
see page 3.

All accessories are sold by the unit, as well as in bags or cartons.  
(unless otherwise stated)

This page only displays a selection of our accessories for X-Tray that have been added via customised needs. If you are missing anything in our product range, do not hesitate to get in touch.

Other coatings by request.

### Conveyor Bracket

Material	Item no.	E-number
Zinc Plated Fzb	7100-025	1133486

### Bend Support Complete kit

Material	Item no.	E-number
Zinc Plated Fzb	7100-028	1133489

Contains bend supports as well as fitting for both sides of the cable tray.

### Wall Bracket Sandwich Element

Material	Item no.	E-number
Length 330 - Zinc Plated Fzb	7100-088	1133511
Length 660 - Zinc Plated Fzb	7100-089	1133512

### Vertical Connector

Material	Item no.	E-number
Zinc Plated Fzb	7100-111	1133611

### Flexible Joint

Material	Item no.	E-number
Zinc Plated Fzb	7100-135	1133615

Sold as a complete kit for 2 sides, 4 pcs X1 Fitting, as well as bolts and nuts.

### Tunnel Bracket

Material	Item no.	E-number
Hot Dip galv. Fzv	7200-179	1132962

### Patch Panel Mount

Material	Item no.	E-number
Zinc Plated Fzb	7100-195	1132958

# OPTIONS

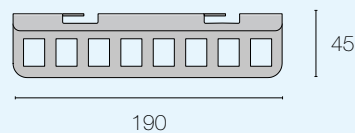
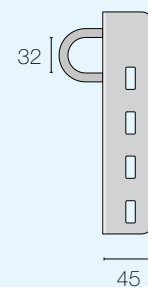
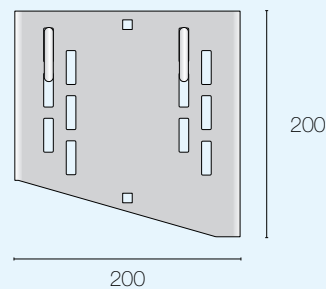
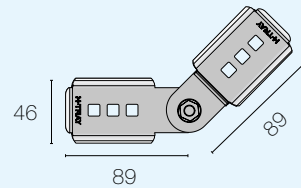
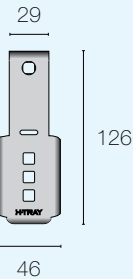
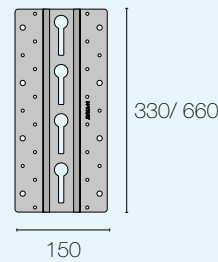
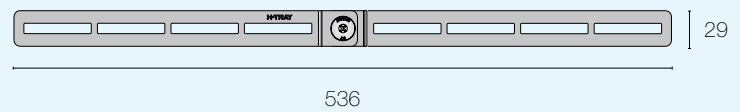
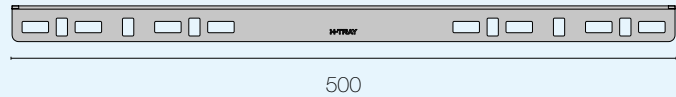
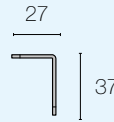

# MOUNTING - HYGIENIC

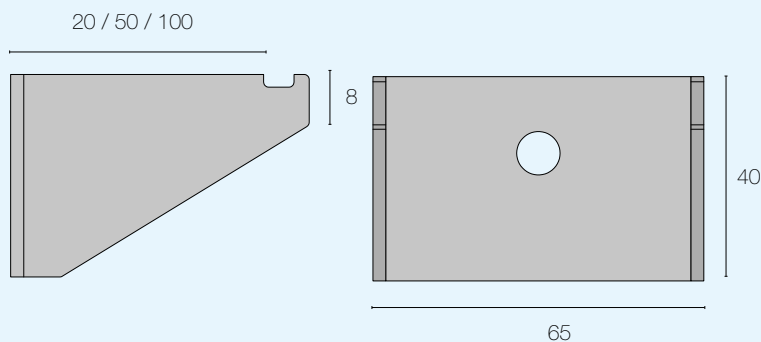
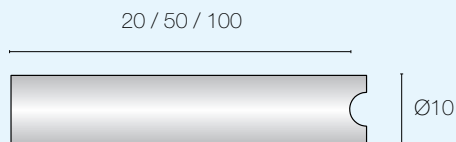
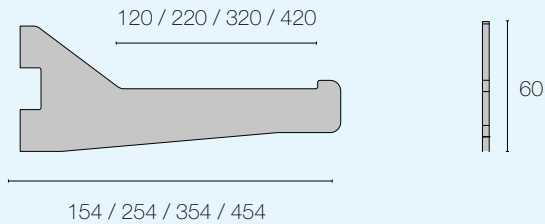
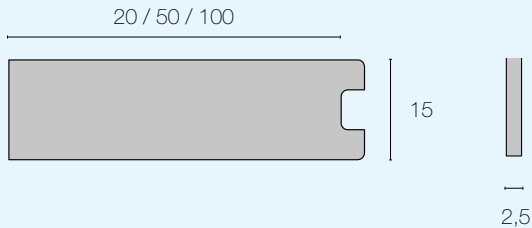
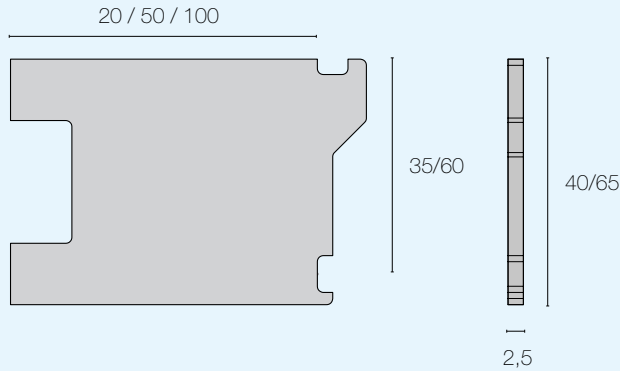

34

65

All measures are in mm.  
For more information about coatings,  
see page 3.

All accessories are sold by the unit, as well as in bags or cartons.  
(unless otherwise stated)

Also see the X10 Bracket, page 10.

The items in this issue are also available with other coatings.  
We also have several models available time permitting.

## Welding Bracket Flat (Page 36)

Material	Item no.	E-number
H35 D20 Stainless 316L	7300-097	1132970
H60 D20 Stainless 316L	7300-098	1132973
H35 D50 Stainless 316L	7300-141	1132971
H60 D50 Stainless 316L	7300-142	1132974
H35 D100 Stainless 316L	7300-143	1132972
H60 D100 Stainless 316L	7300-144	1132975

## Welding Bracket Flat (Page 36)

Material	Item no.	E-number
D20 Stainless 316L	7300-110	1132967
D50 Stainless 316L	7300-145	1132968
D100 Stainless 316L	7300-146	1132969

## Welding Cantilever Flat (Page 36)

Material	Item no.	E-number
D120 Stainless 316L	7300-171	1132999
D220 Stainless 316L	7300-172	1133002
D320 Stainless 316L	7300-173	1133003
D420 Stainless 316L	7300-174	1133004

## Welding Bracket Round (Page 36)

Material	Item no.	E-number
D20 Stainless 316L	7300-156	1132964
D50 Stainless 316L	7300-157	1132965
D100 Stainless 316L	7300-158	1132966

## Welding Bracket X10 (Page 36)

Material	Item no.	E-number
D20 Stainless 316L	7300-149	1132976
D50 Stainless 316L	7300-152	1132977
D100 Stainless 316L	7300-155	1132978

All measures are in mm.  
For more information about coatings,  
see page 3.

All accessories are sold by the unit, as well as in bags or cartons.  
(unless otherwise stated)

Also see the X10 Bracket, page 10.

The items in this issue are also available with other coatings.  
We also have several models available time permitting.

### Welding Bracket X10 (Page 36)

Material	Item no.	E-number
H35 D20 Stainless 316L	7300-147	1132979
H60 D20 Stainless 316L	7300-148	1132982
H35 D50 Stainless 316L	7300-150	1132980
H60 D50 Stainless 316L	7300-151	1132983
H35 D100 Stainless 316L	7300-153	1132981
H60 D100 Stainless 316L	7300-154	1132984

### Welding Cantilever Strong (Page 36)

Material	Item no.	E-number
D120 Stainless 316L	7300-163	1132991
D220 Stainless 316L	7300-164	1132992
D320 Stainless 316L	7300-165	1132993
D420 Stainless 316L	7300-166	1132994

### Welding Cantilever (Page 36)

Material	Item no.	E-number
D120 Stainless 316L	7300-167	1132995
D220 Stainless 316L	7300-168	1132996
D320 Stainless 316L	7300-169	1132997
D420 Stainless 316L	7300-170	1132998

### Bracket (Page 37)

Material	Item no.	E-number
H35 D20 Stainless 316L	7300-159	1132985
H60 D20 Stainless 316L	7300-160	1132988
H35 D50 Stainless 316L	7300-161	1132986
H60 D50 Stainless 316L	7300-162	1132989
H35 D100 Stainless 316L	7300-115	1132987
H60 D100 Stainless 316L	7300-117	1132990

### Bracket X10 (Page 37)

Material	Item no.	E-number
H60 D100 Stainless 304L	7400-104	1133609
H35 D100 Stainless 304L	7400-109	1133610

# MOUNTING - HYGIENIC

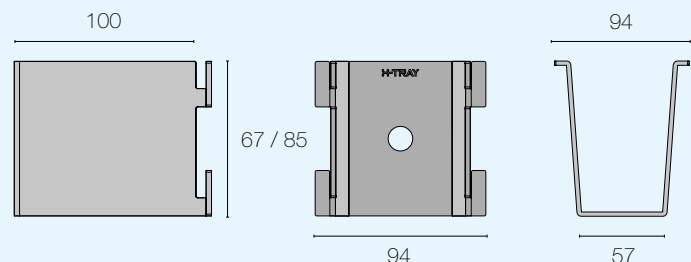
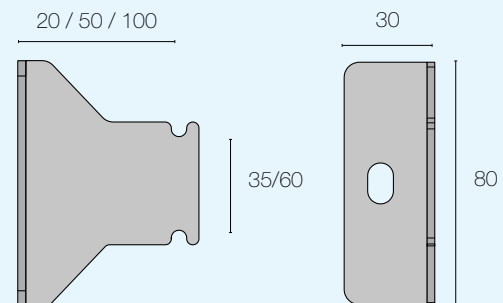
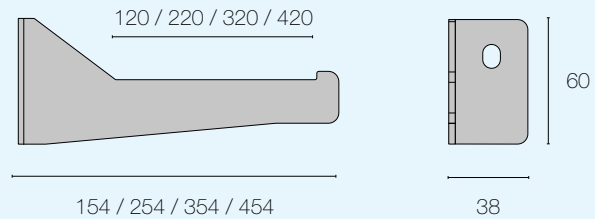
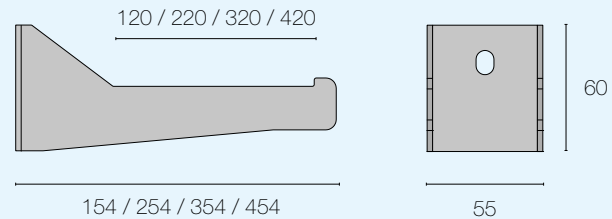
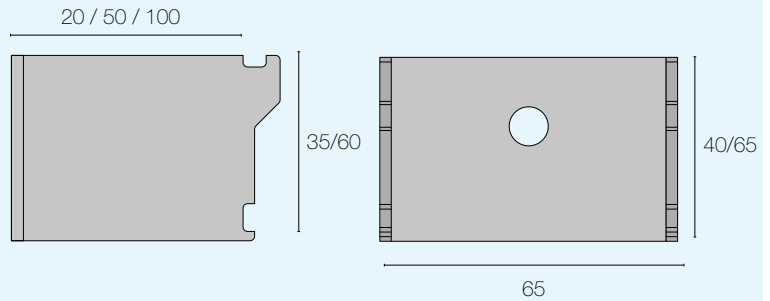

35

Hygiene

# MOUNTING - HYGIENIC

All measures are in mm.  
For more information about coatings,  
see page 3.



All accessories are sold by the unit, as well as in bags or cartons.  
(unless otherwise stated)

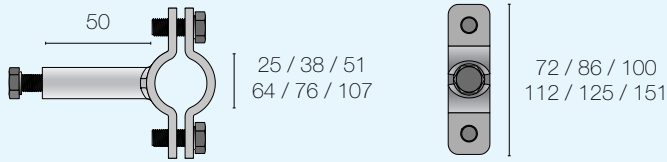

## Pipe Clamp (Page 37)

Material	Item no.	E-number
Ø25 D50 Stainless 316L	7300-276	1133619
Ø38 D50 Stainless 316L	7300-277	1133620
Ø51 D50 Stainless 316L	7300-278	1133621
Ø64 D50 Stainless 316L	7300-279	1133622
Ø76 D50 Stainless 316L	7300-280	1133623
Ø107 D50 Stainless 316L	7300-281	1133624

With hygienic Material that is specially adapted for the foodindustry.



# INSTALLATION **WELDING BRACKETS**

7300-097/098/141/142/143/144

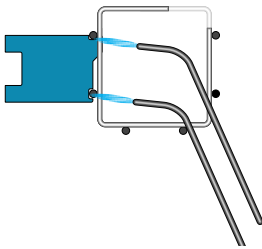

7300-110/145/146

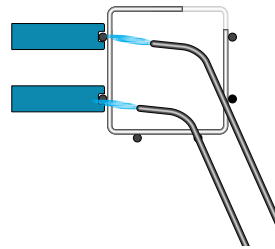

7300-147/148/150/151/153/154

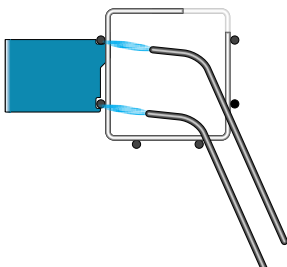

7300-156/157/158

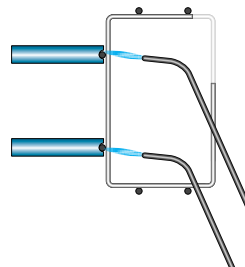

7300-163/164/165/166

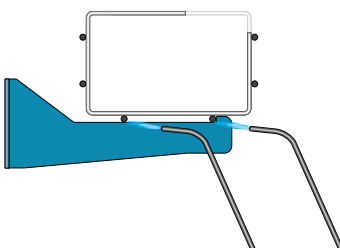

7300-167/168/169/170

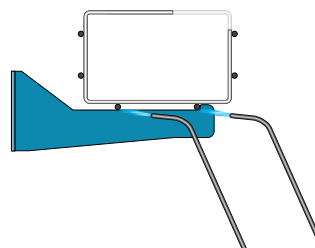

# INSTALLATION **PIPE CLAMPS**



7300-276/277/278/279/280/281

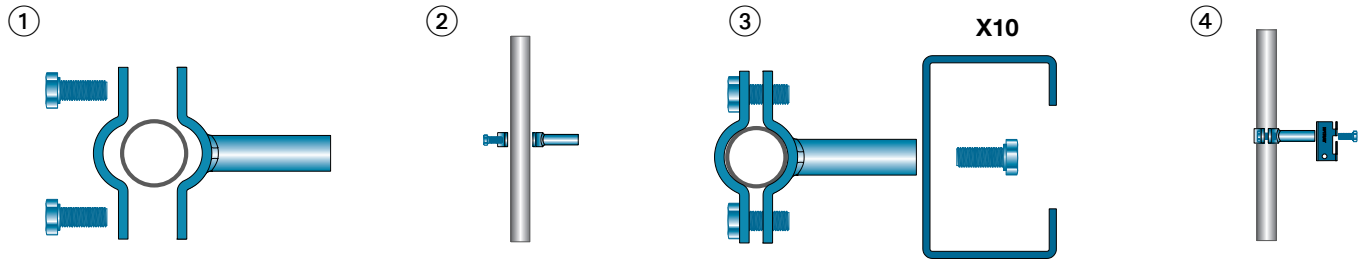

# INSTALLATION **BRACKETS**



7300-115/117/159/160/161/162

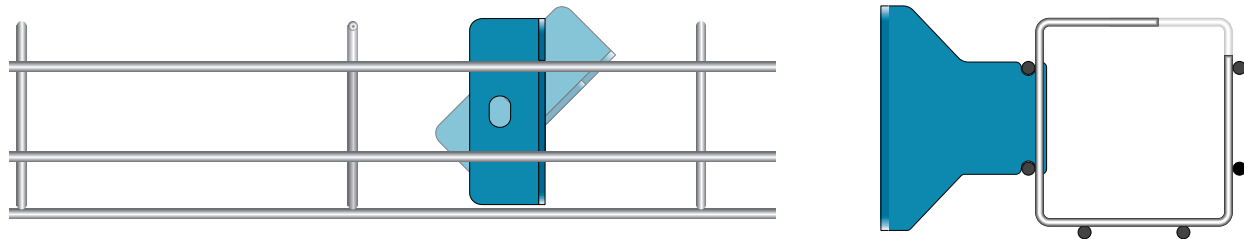

7300-104/109

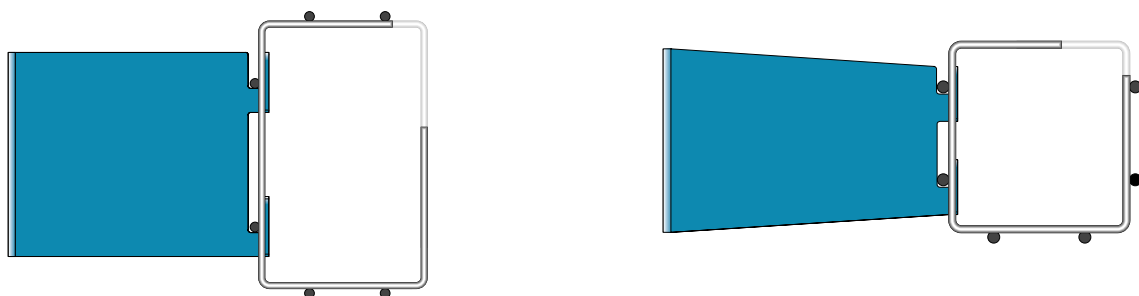

# X-RACK

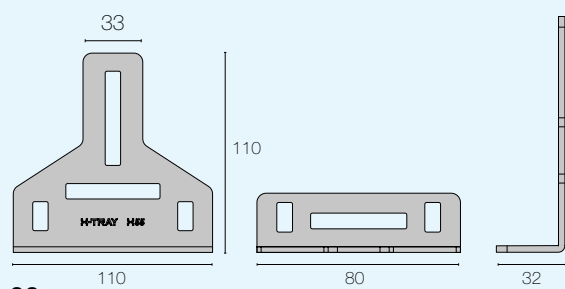
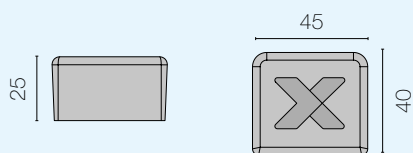
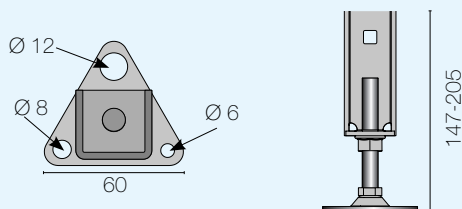
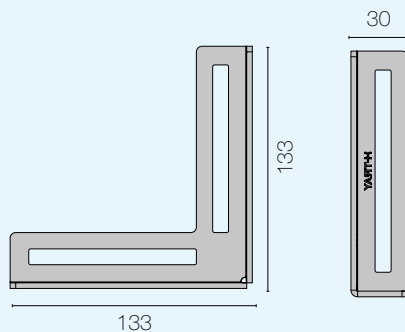
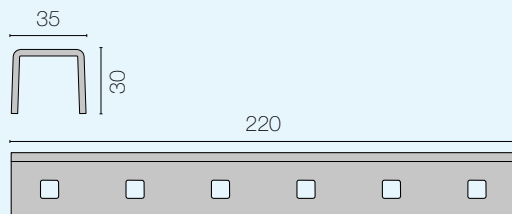
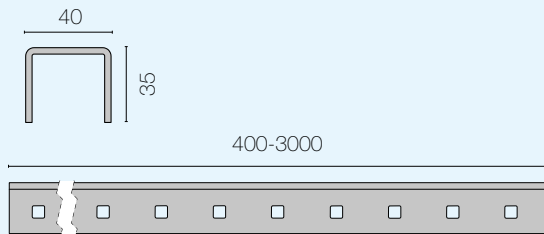

38



All accessories are sold by the unit, as well as in bags or cartons.  
(unless otherwise stated)

## X50 U-Bar 400-3000 mm (Page 57)

Material	Item no.	E-number	Length:
Zinc Plated Fzb	2150-400	1133239	400
Zinc Plated Fzb	2150-520	1133240	520
Zinc Plated Fzb	2150-600	1133241	600
Zinc Plated Fzb	2150-720	1133242	720
Zinc Plated Fzb	2150-800	1133243	800
Zinc Plated Fzb	2150-920	1133244	920
Zinc Plated Fzb	2150-1000	1133245	1000
Zinc Plated Fzb	2150-1920	1133246	1920*
Zinc Plated Fzb	2150-2120	1133247	2120*
Zinc Plated Fzb	2150-2480	1133248	2480*
Zinc Plated Fzb	2150-3000	1133249	3000*



 \* 72 pcs / pallet

## X51 U-Bar Joining Fitting (Page 58)

Material	Item no.	E-number	Bag  / Carton 
Zinc Plated Fzb	2151	1133250	8 / 16



Used to extend threaded U-bars.

## X52 U-Bar Corner Fitting (Page 58-59)

Material	Item no.	E-number	Bag  / Carton 
Zinc Plated Fzb	2152	1133251	8 / 32



Used when installing U-bars.

## X53 U-Bar Adjustable Foot (Page 59)

Material	Item no.	E-number	Bag  / Carton 
Zinc Plated Fzb	2153	1133252	8 / 16

The adjustable foot is used to compensate for the difference in height on uneven floors.

## X54 U-Bar End Cap

Material	Item no.	E-number	Bag  / Carton 
Black plastic	2554	1133369	10 / 80

Safety guard for X-bar ends.

## X55 U-Bar Angle Fitting (Page 59)

Material	Item no.	E-number	Carton 
Zinc Plated Fzb	2155	1132916	30

# X-RACK

All accessories are sold by the unit, as well as in bags or cartons.  
(unless otherwise stated)

## X60 Radius Limiter 120 (Page 64)

Material	Item no.	E-number	Carton
Zinc Plated Fzb	2160-120	1133253	8

## X60 Radius Limiter 220 (Page 64)

Material	Item no.	E-number	Carton
Zinc Plated Fzb	2160-220	1133254	8

## X60 Radius Limiter 320 (Page 64)

Material	Item no.	E-number	Carton
Zinc Plated Fzb	2160-320	1133255	8

## X60 Radius Limiter 420 (Page 64)

Material	Item no.	E-number	Carton
Zinc Plated Fzb	2160-420	1133256	8

Reduces bending radius for sensitive cables.  
Can be combined for greater width.

## X69 Side Radius Limiter (Page 65)

Material	Item no.	E-number	Carton
Zinc Plated Fzb	2169	1132932	10

Reduces bending radius for sensitive cables.

## X61 Carriage Bolt M8x27, 40 pack (Page 42-43)

Material	Item No.	E-number	Bag	Carton
Zinc Plated Fzb	2161	1133257	1	10

## X62 Distance Nut M8, 40 pack (Page 42-43)

Material	Item No.	E-number	Bag	Carton
Zinc Plated Fzb	2162	1133258	1	10

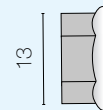
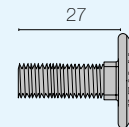
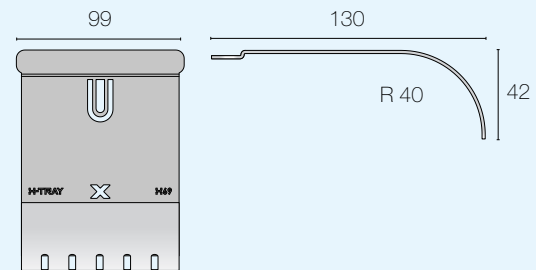
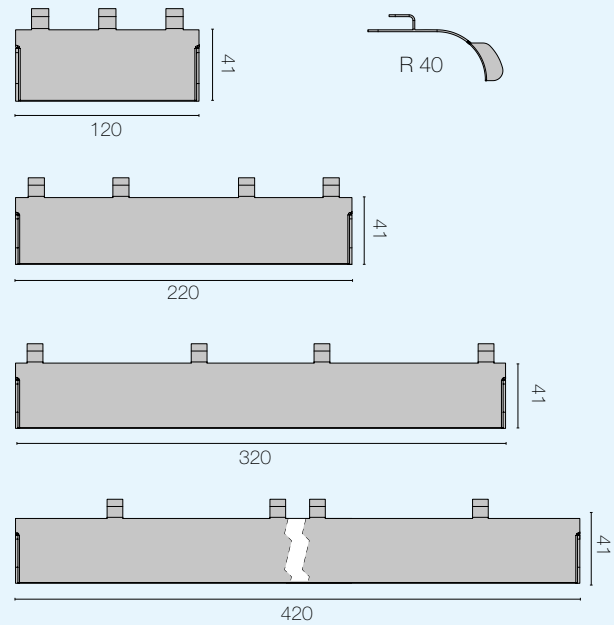



# X-RACK

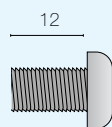
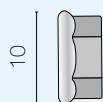
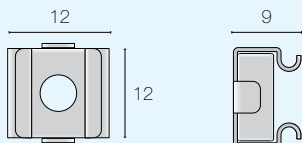
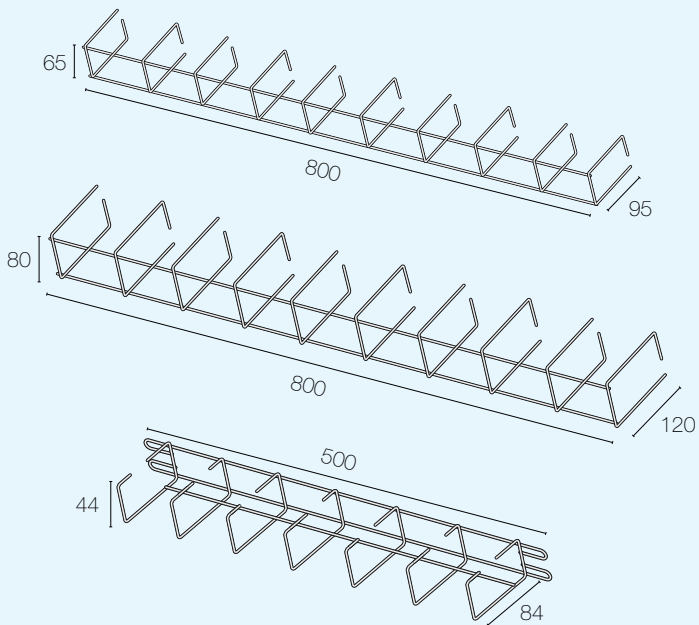
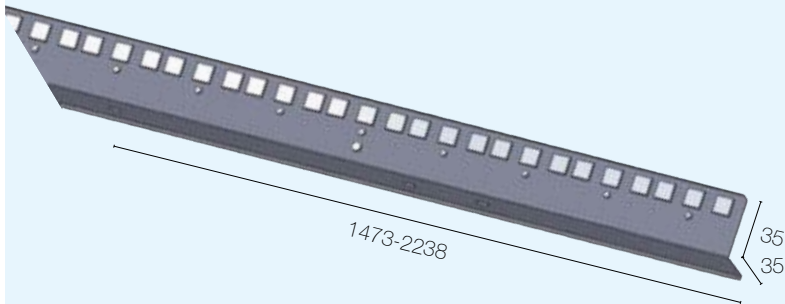
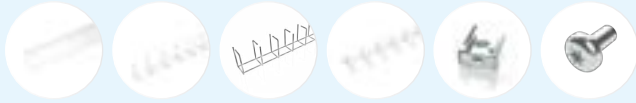

All accessories are sold by the unit, as well as in bags or cartons.  
(unless otherwise stated)

## Mounting Profile 1876 mm 42U incl. bolts & nuts

Material	Item no.	E-number
Zinc Plated Fzb	7100-050	1133492

## Mounting Profile 2060 mm 46U incl. bolts & nuts

Material	Item no.	E-number
Zinc Plated Fzb	7100-051	1133493

## Mounting Profile 2238 mm 50U incl. bolts & nuts

Material	Item no.	E-number
Zinc Plated Fzb	7100-058	1133499

## Mounting Profile 1473 mm incl. bolts & nuts

Material	Item no.	E-number
Zinc Plated Fzb	7100-198	1132957

For battery rack.

## Cable Duct Small 95x65x800 mm incl. mounting parts

Material	Item no.	E-number
Zinc Plated Fzb	7100-052	1133494

## Cable Duct Large 120x80x800 mm incl. mounting parts

Material	Item no.	E-number
Zinc Plated Fzb	7100-250	1132953

## Cable Duct 19" Horizontal incl. mounting parts

Material	Item no.	E-number
Zinc Plated Fzb	7100-054	1133495

## Cage Nut M6

Material	Item no.	E-number
Zinc Plated Fzb	7100-055	1133496

## Flange Nut M6

Material	Item no.	E-number
Zinc Plated Fzb	7100-056	1133497

## Torx Screw M6x12

Material	Item no.	E-number
Zinc Plated Fzb	7100-057	1133498

# X-RACK



All accessories are sold by the unit, as well as in bags or cartons.  
(unless otherwise stated)

## Mounting profile ETSI 1876 mm

Material	Item no.	E-number
Zinc Plated Fzb	7100-078	1133505

## Mounting profile ETSI 2060 Fzb

Material	Item no.	E-number
Zinc Plated Fzb	7100-079	1133506

## Adapter ETSI to 19"

Material	Item no.	E-number
Zinc Plated Fzb	7100-080	1133507

## X-Rack Floor Plate 300 Fzb

Material	Item no.	E-number
Zinc Plated Fzb	7100-220	1132949

Requires 2 pcs for one X-Rack

## X-Rack Shelf 600 Fzb

Material	Item no.	E-number
Zinc Plated Fzb	7100-221	1132951

## X-Rack Kit (Page 43)

Material	Item no.	E-number
2000x600 Small cable duct - Zinc Plated Fzb	7100-200	1133514
2200x600 Small cable duct - Zinc Plated Fzb	7100-201	1133515
2000x600 Battery rack, small cable duct - Z.P Fzb	7100-202	1132947
2000x600 Large cable duct - Zinc Plated Fzb	7100-204	1132933
2200x600 Large cable duct - Zinc Plated Fzb	7100-205	1132946
2000x600 Battery rack, large cable duct - Z.P Fzb	7100-206	1132948

## X-Rack Ready-assembled side (Page 42)

Material	Item no.	E-number
2000x600 Zinc Plated Fzb	7100-210	1133516
2200x600 Zinc Plated Fzb	7100-211	1133517

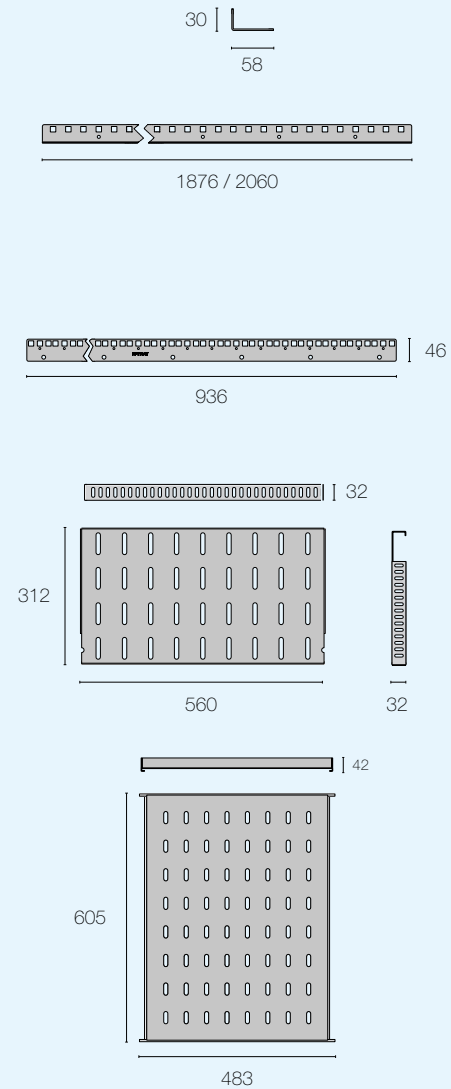

X-Rack

# X-RACK INSTALLATION

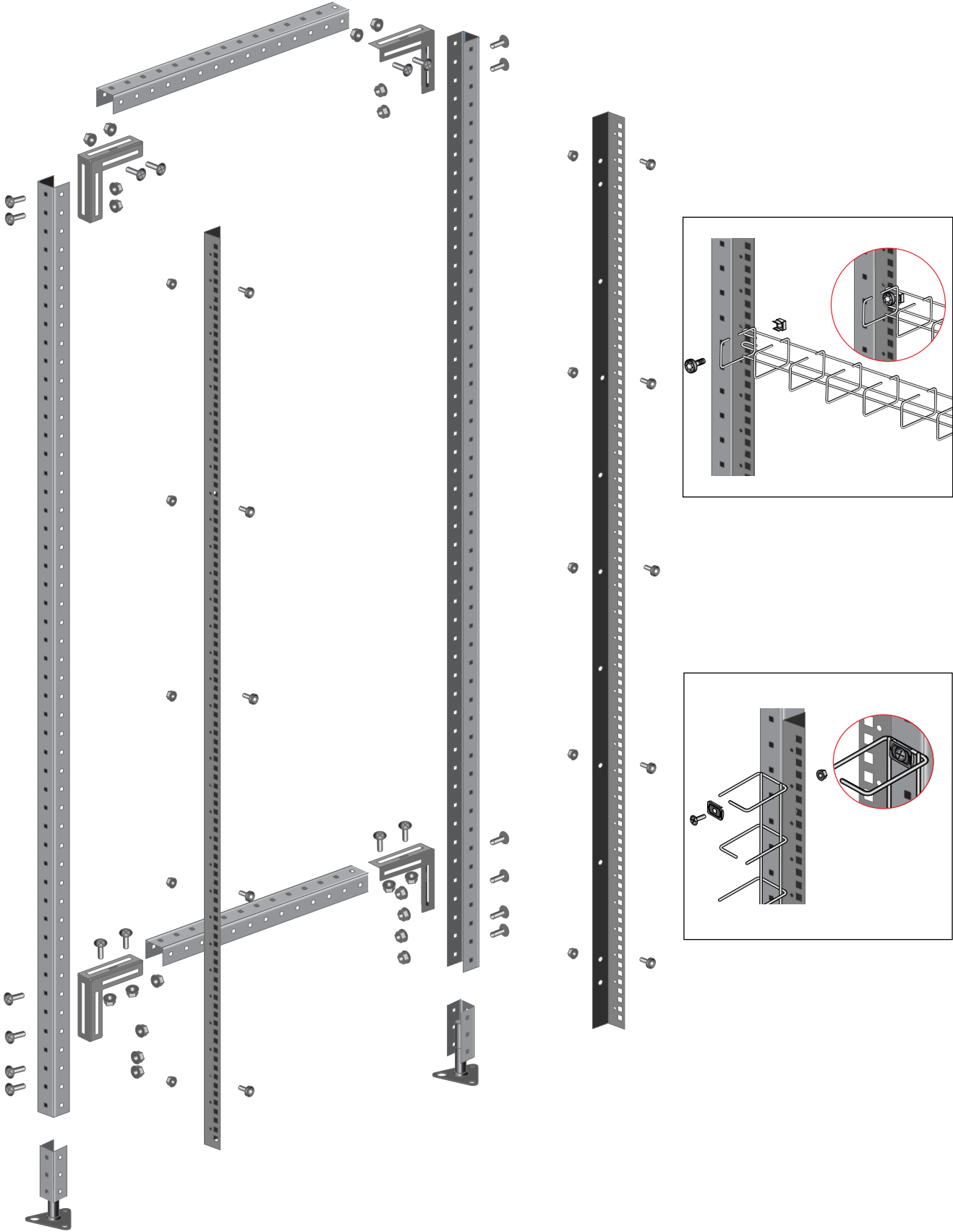

# X-RACK EXTENSION

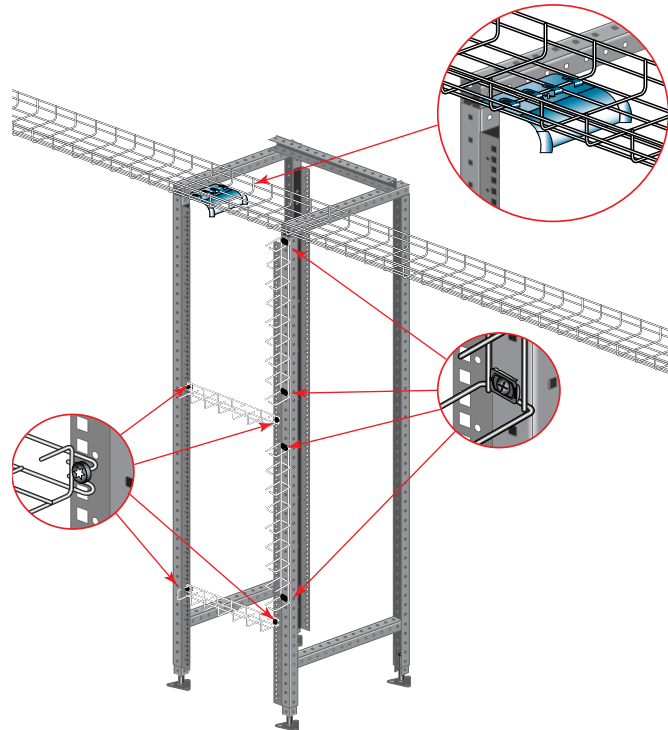

X-Rack



# X5 JOINING

Used for X-Tray U-trays with 60 & 110 mm sides, as well as C & G.

## INSTALLATION

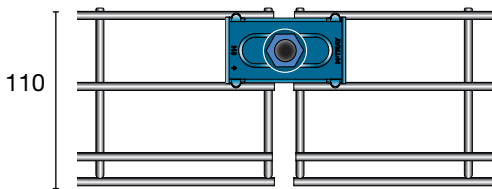
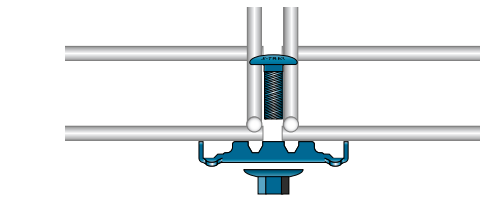
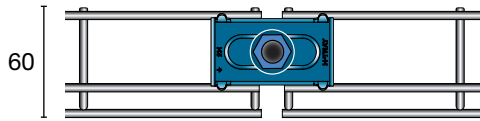

U  
53-220

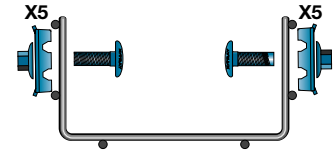
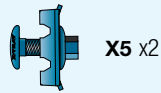

U  
320

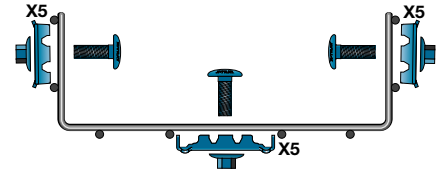
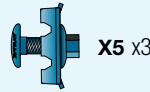

U  
420 - 620

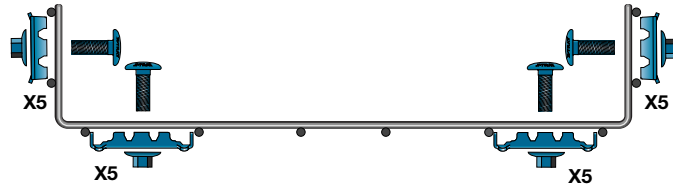
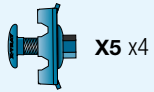

G  
60x100

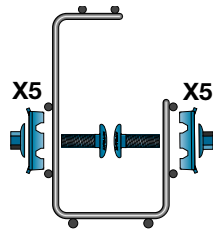
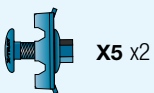
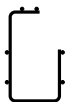

C  
70x68  
120x80

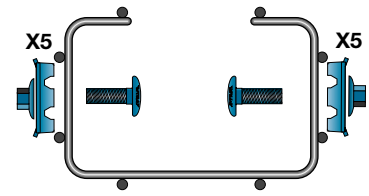
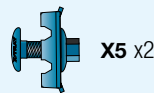
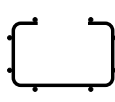

G  
120x150

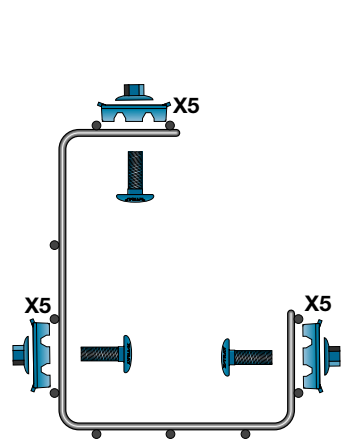
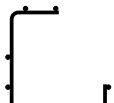

C  
220x120

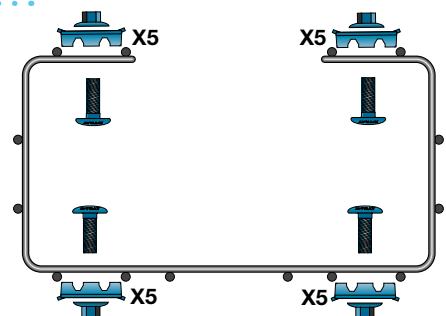



# X5 JOINING

Used for X-Tray Z-trays 53-120 mm.

# X5 MINI JOINING

Used for X-Tray Z-trays 42x42.

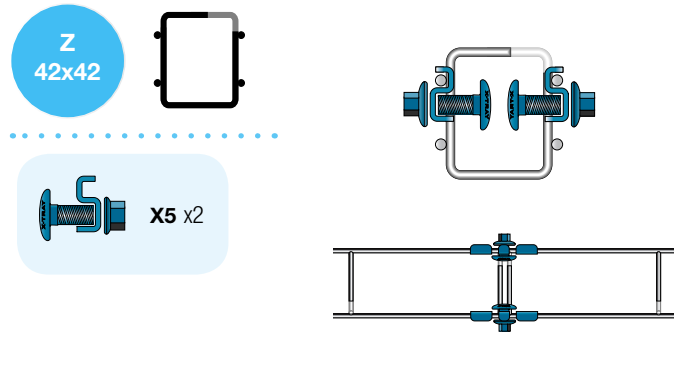
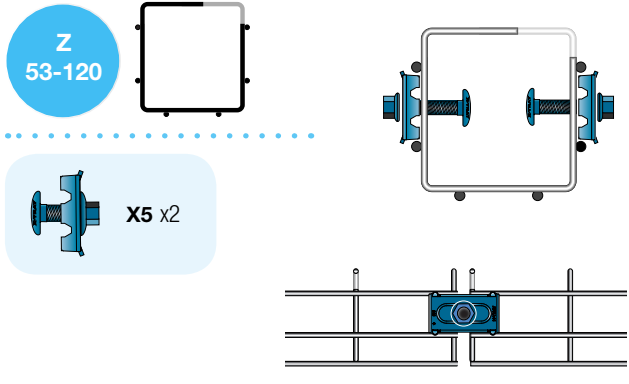

# X5 MINI JOINING

Used for X-Tray U-trays with low side, 30 mm.

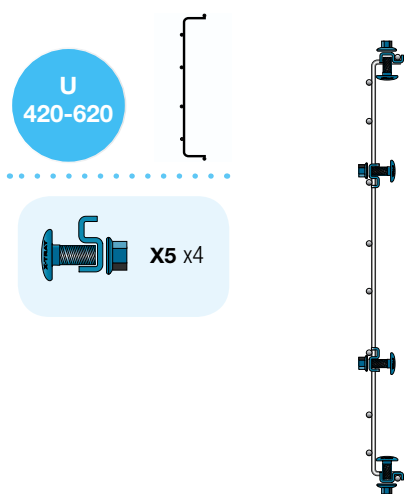
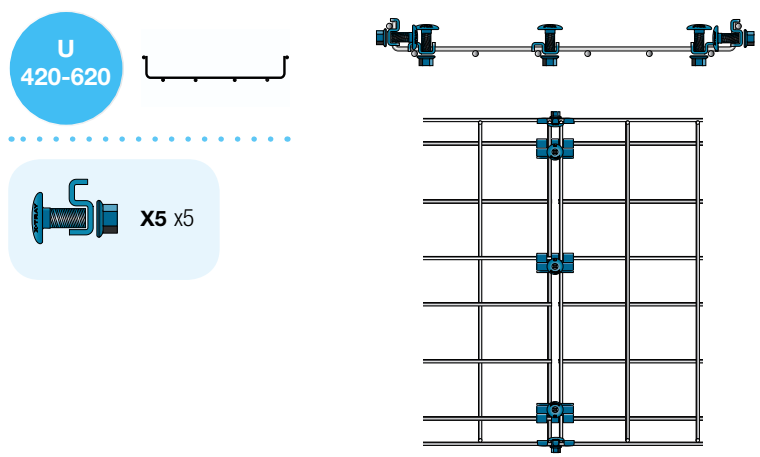
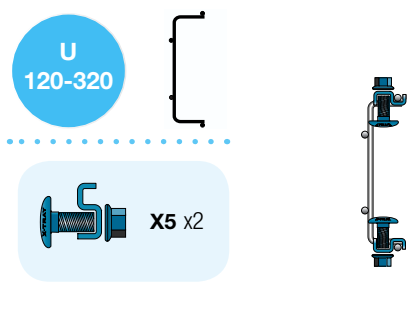
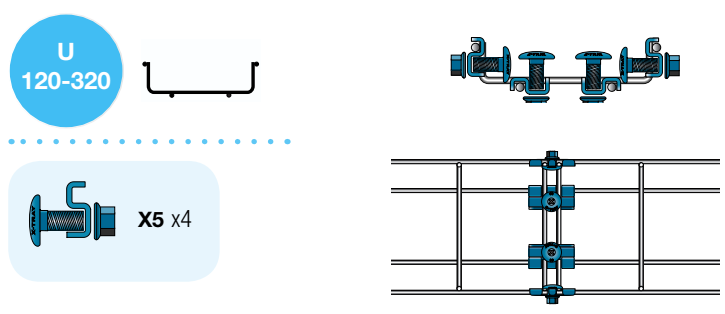
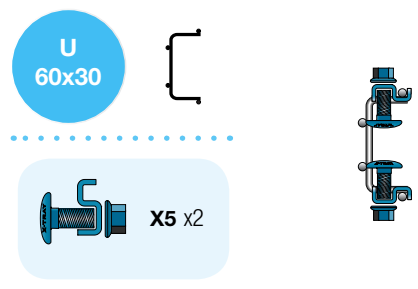
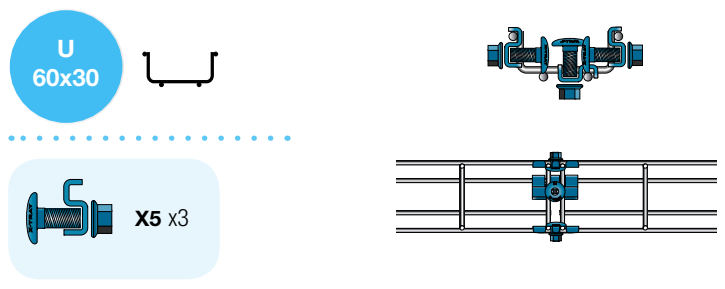

Installation



# X1 & X4 CORNER

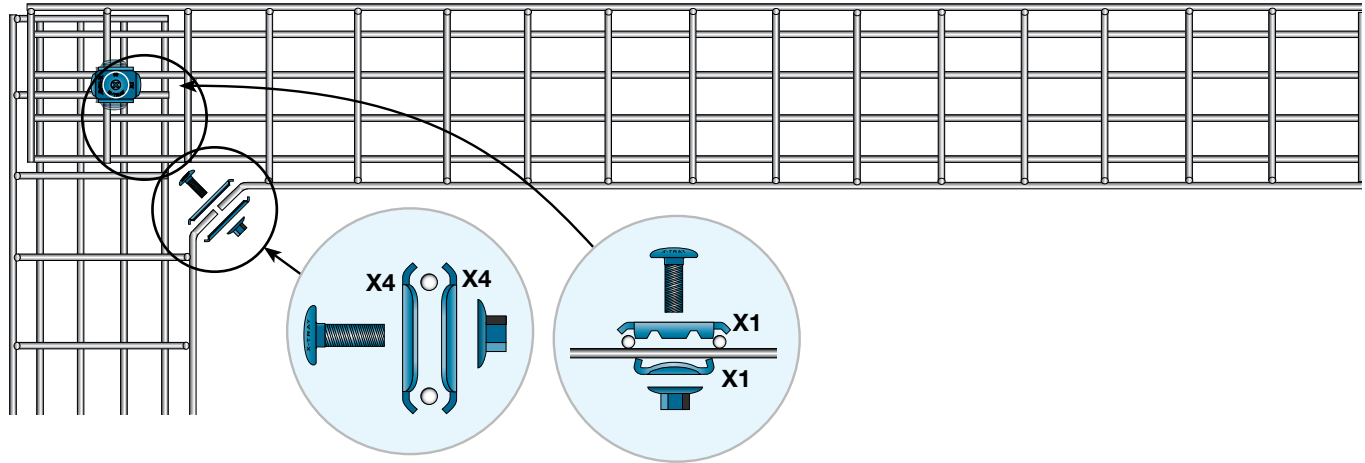

**53-220**

---

**X1 x2    X4 x2    X62 x2    X61 x2**

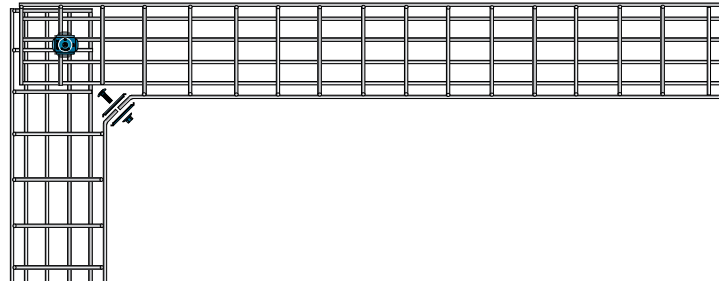

**320-420**

---

**X1 x4    X4 x2    X62 x3    X61 x3**

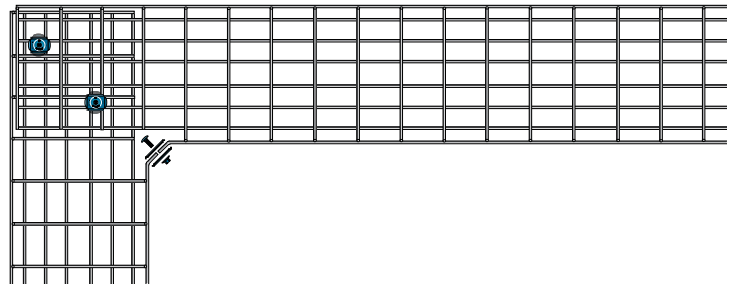

**520-620**

---

**X1 x6    X4 x2    X62 x4    X61 x4**

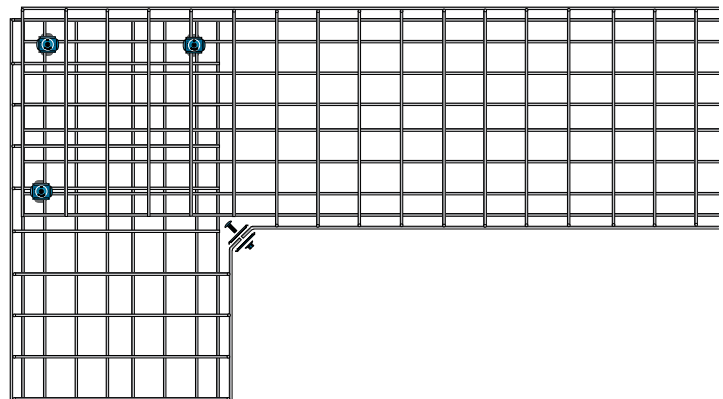

# X3 & X1 ANGLE ADJUSTMENT

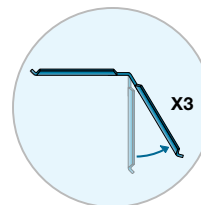
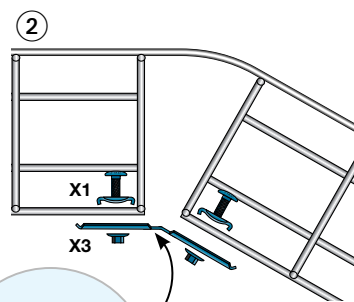
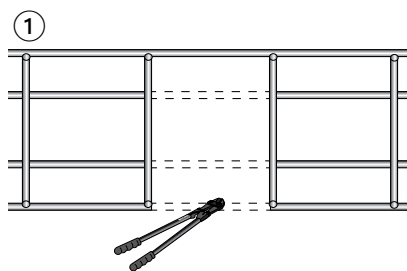
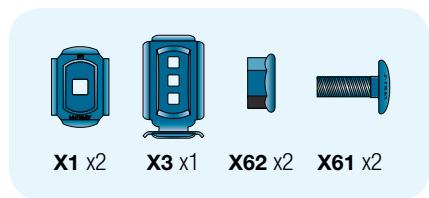
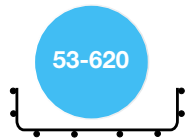





# X2 RADIUS

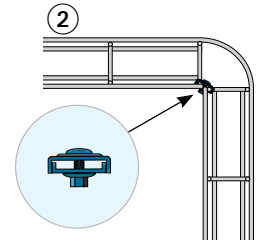
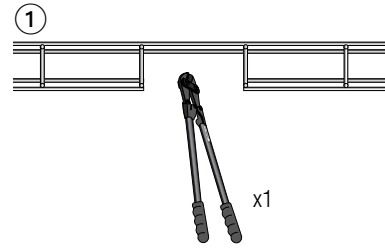
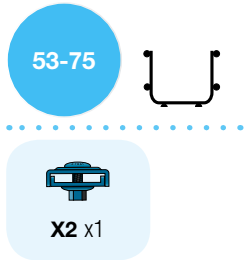
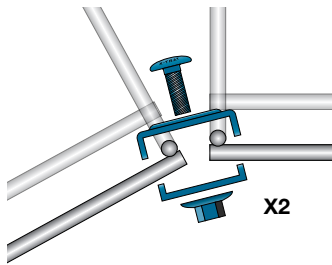

\* The radius does not become exactly 90 degrees.

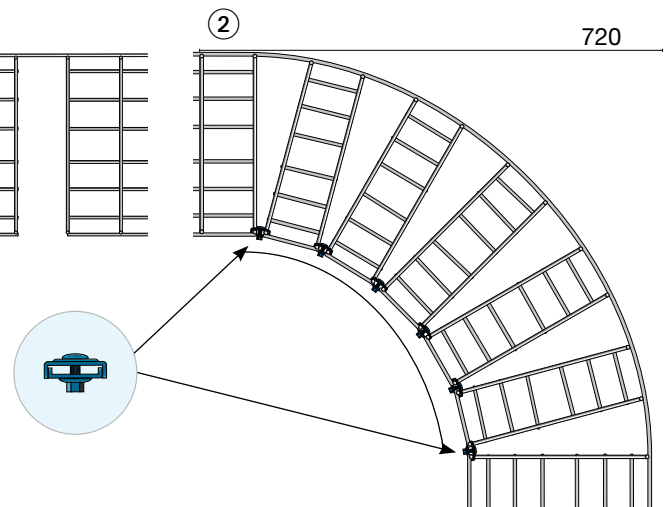
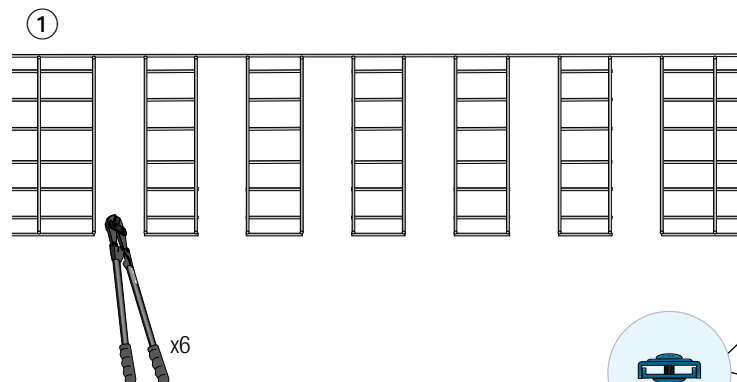
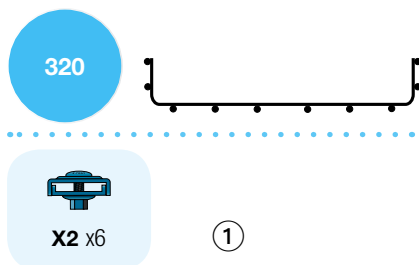
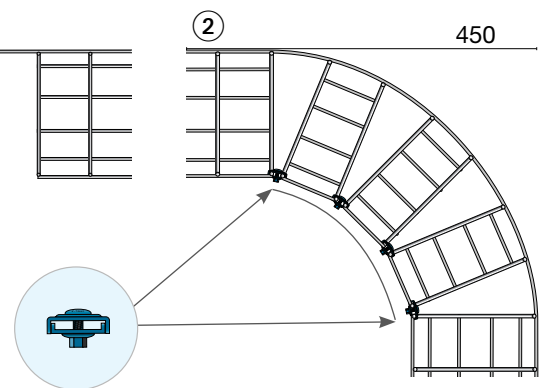
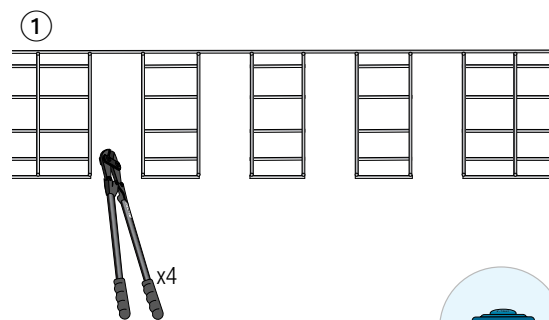
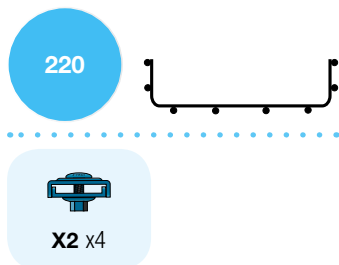
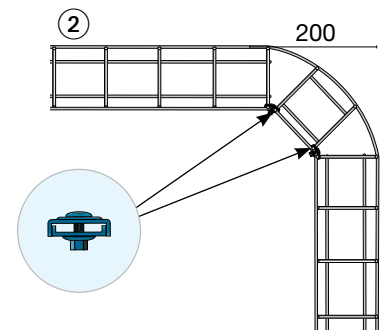
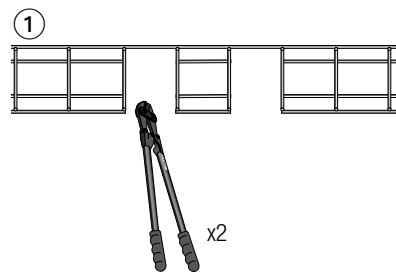
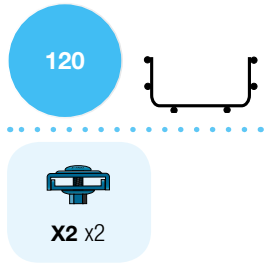

# X2 RADIUS



420



X2 x8

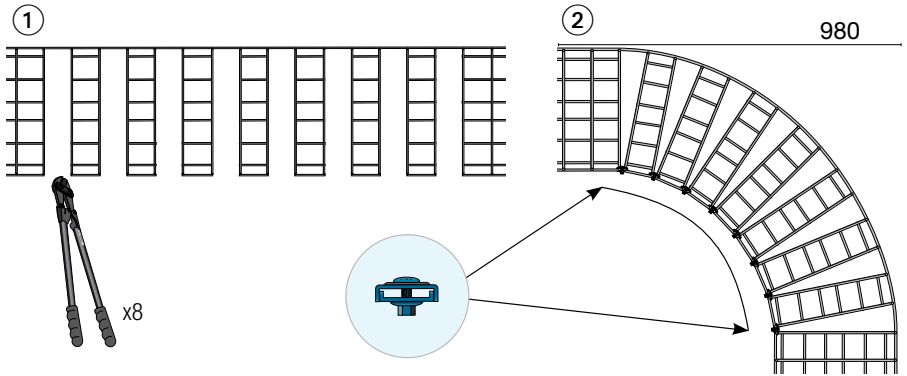

520

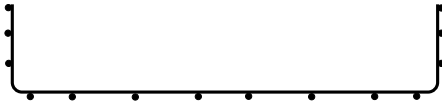

X2 x10

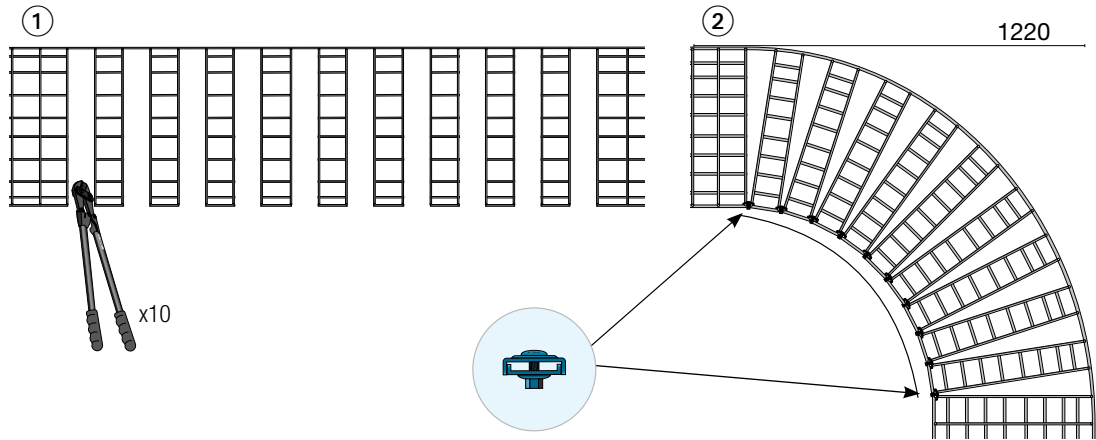

620



X2 x12

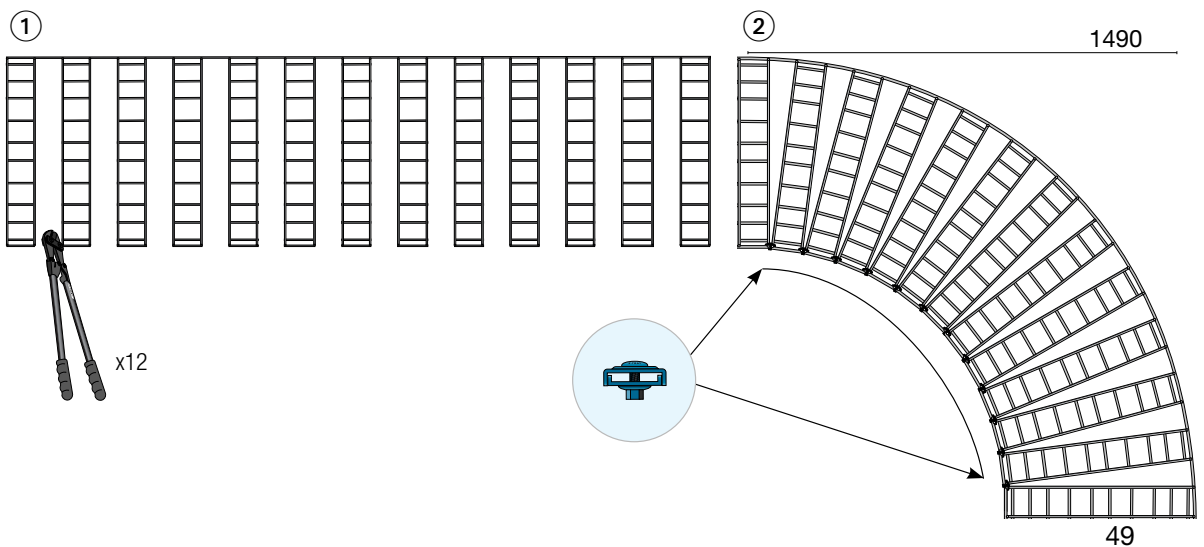

Installation



# X1 & X4 REDUCTION

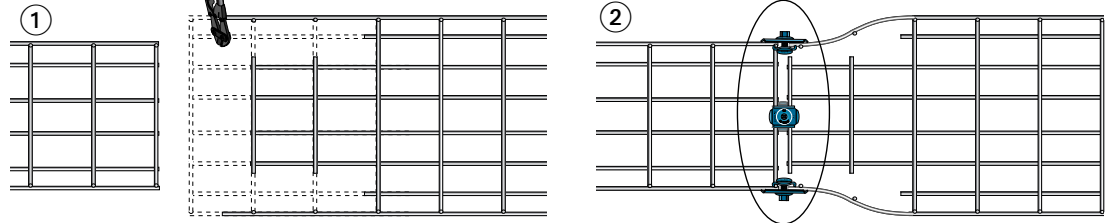
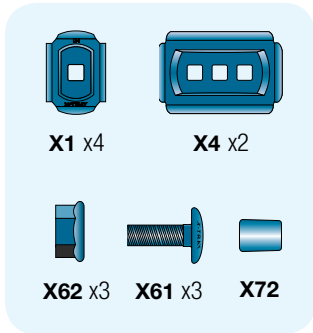
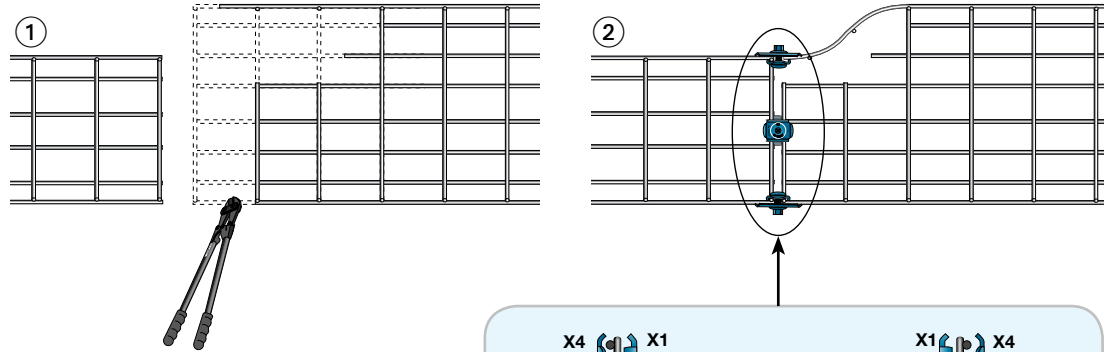
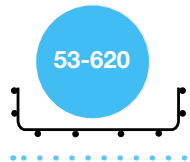

# X2 ANGLE DOWN/UP

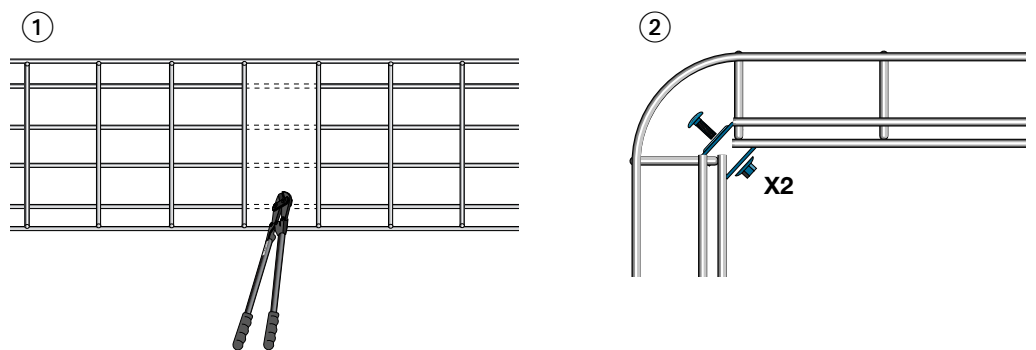
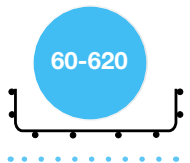

Without fittings

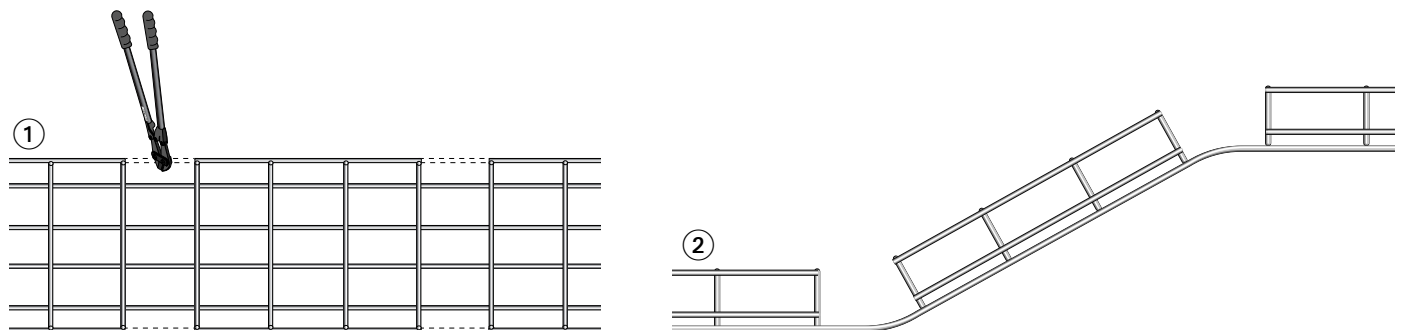

# X1 & X3 T-JUNCTION



53-620



X1 x4



X3 x2



X62 x4



X61 x4



X72

①

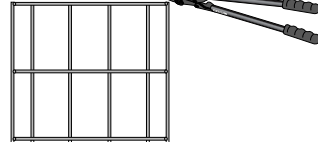
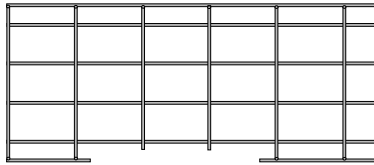

②

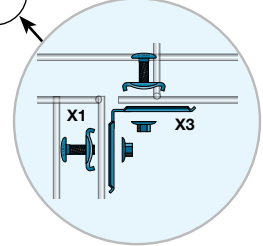
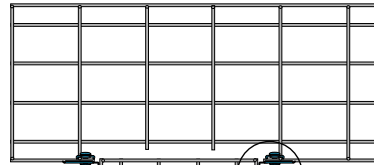

①

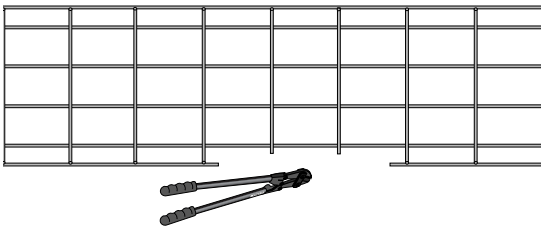

②

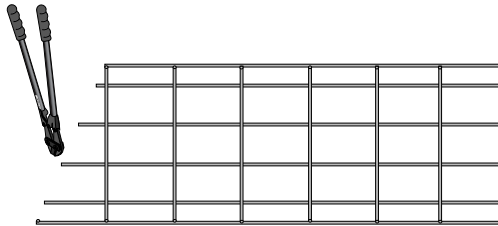

③

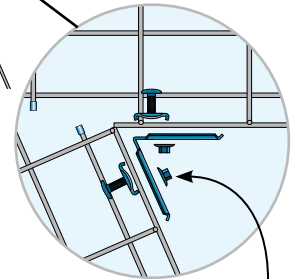
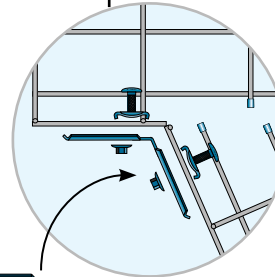
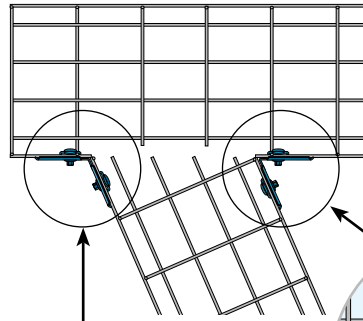

X3

X3

# X2 T-JUNCTION



53-620



X2 x2



X72

①

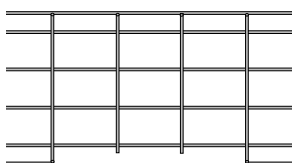

②

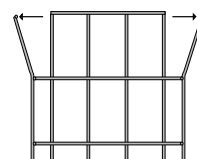

③

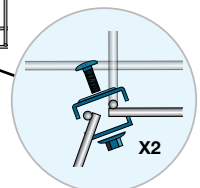
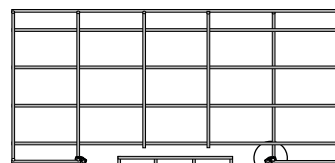



## X3 & X1 MOUNTING

53-620

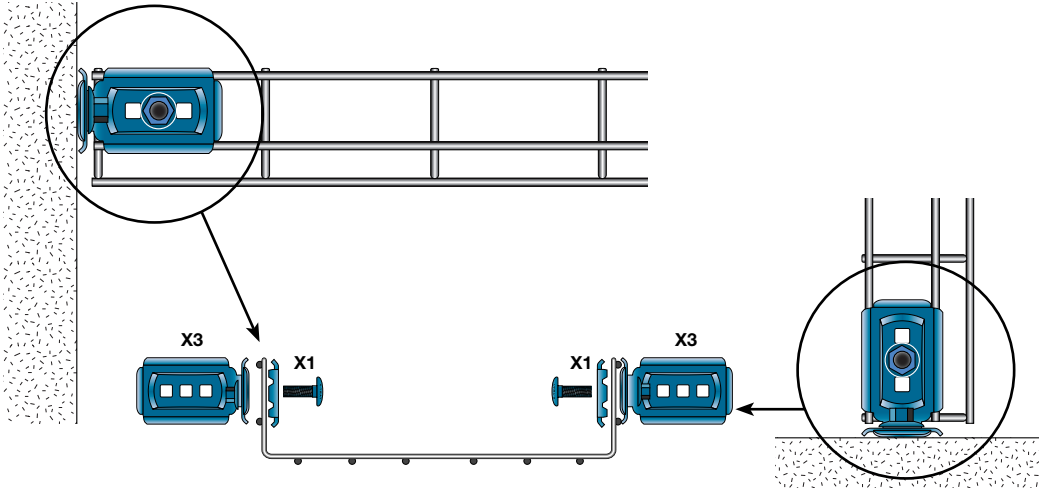
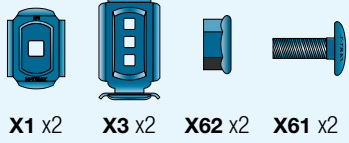

## X4 MOUNTING

60-620

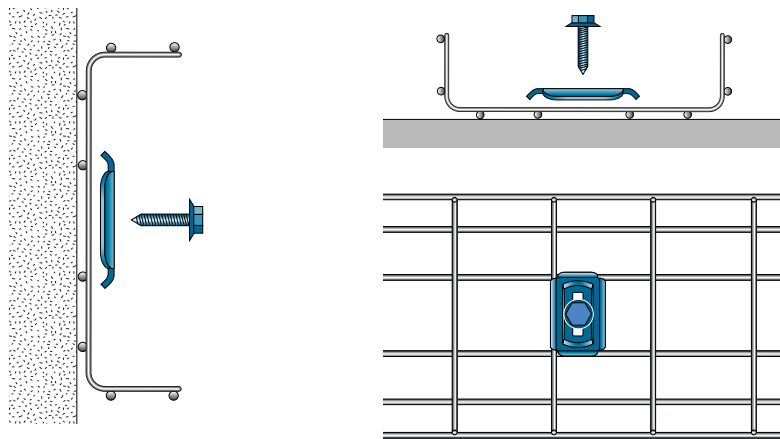
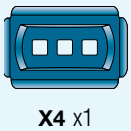

## X15 MOUNTING

53-320

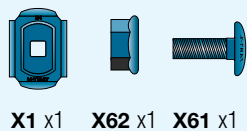
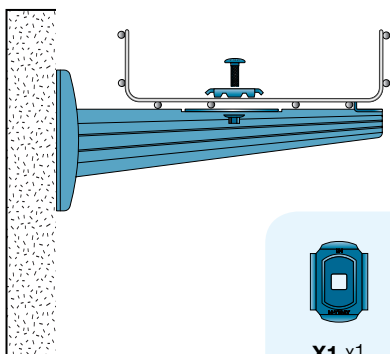

52

420-620

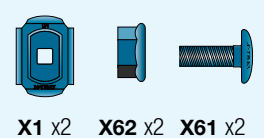
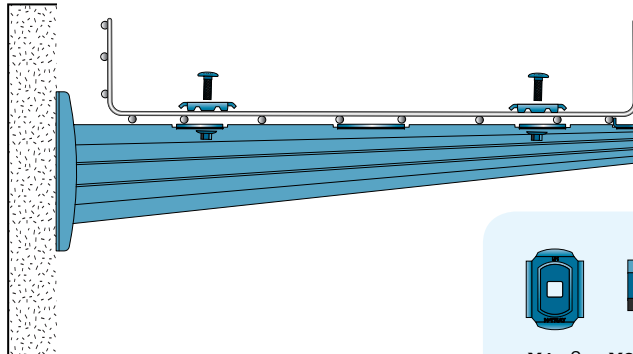

# X10 MOUNTING



53-120



X10 Mini for 4 mm wire  
X10 for 5 mm wire

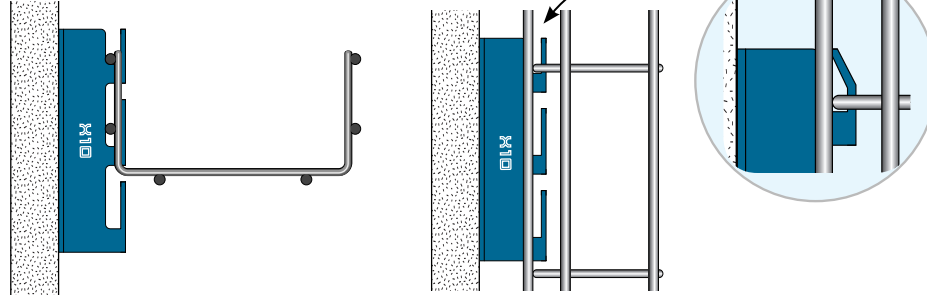

60-620



60-620

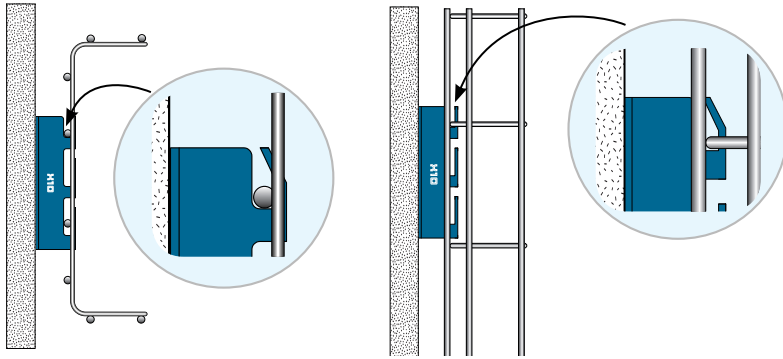

60-220

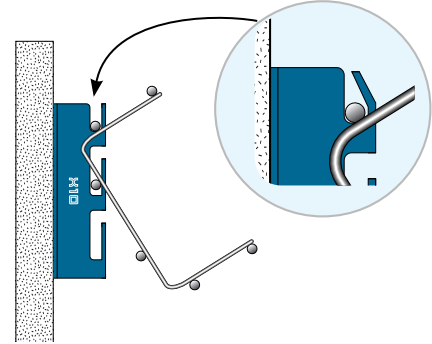
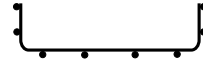

60-120



(For cable trays with 30 mm side.)

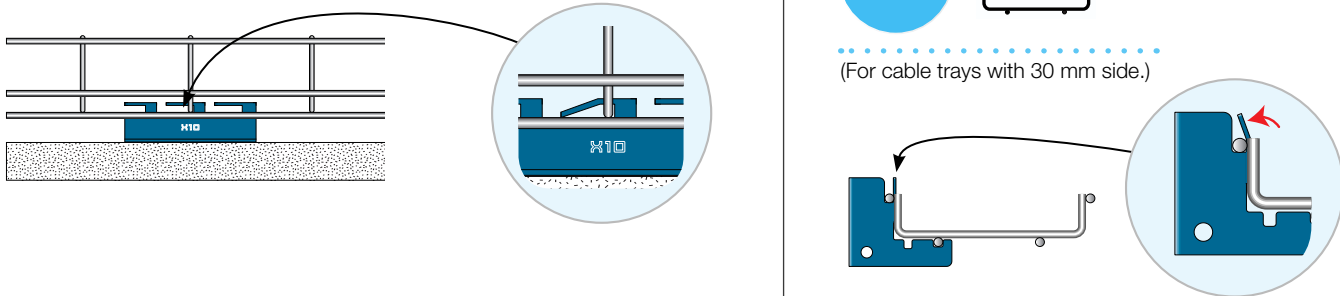

# X19 MOUNTING



60-320

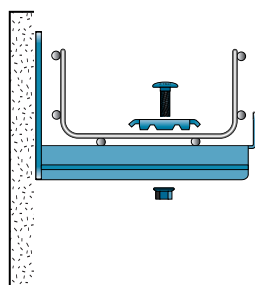
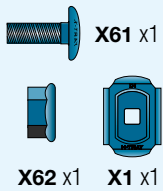

420-620

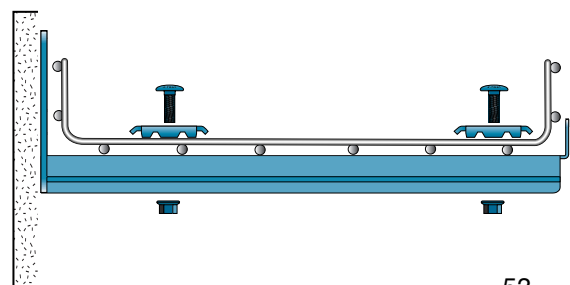
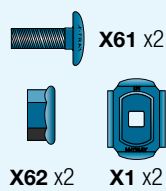
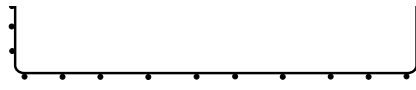

Installation



# X14 MOUNTING

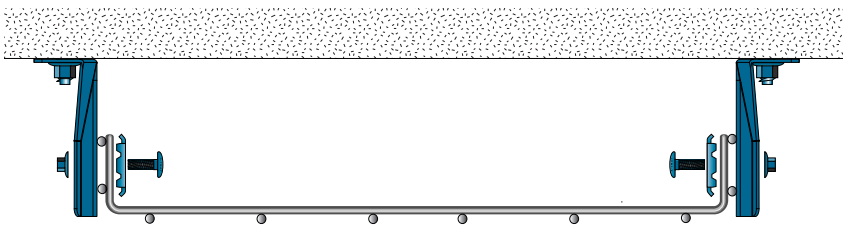
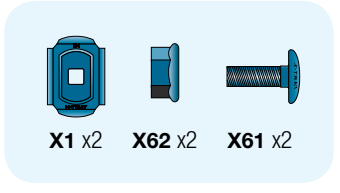
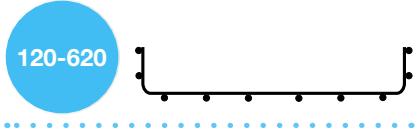
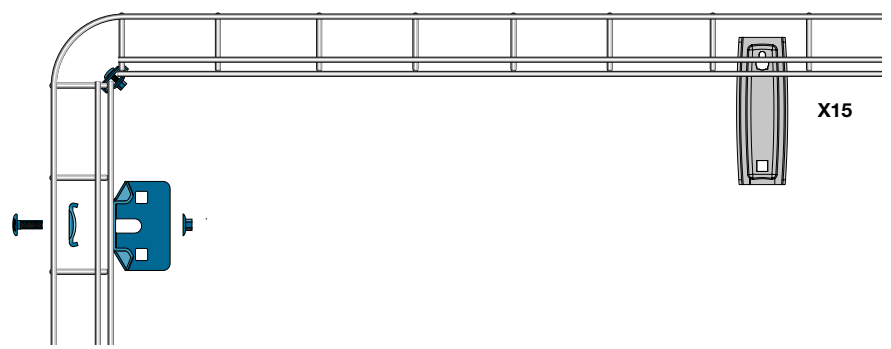
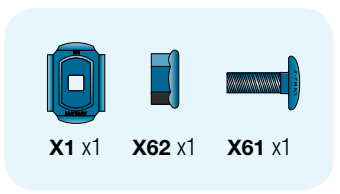
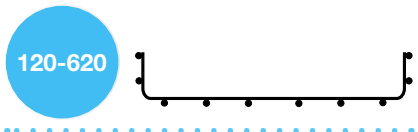
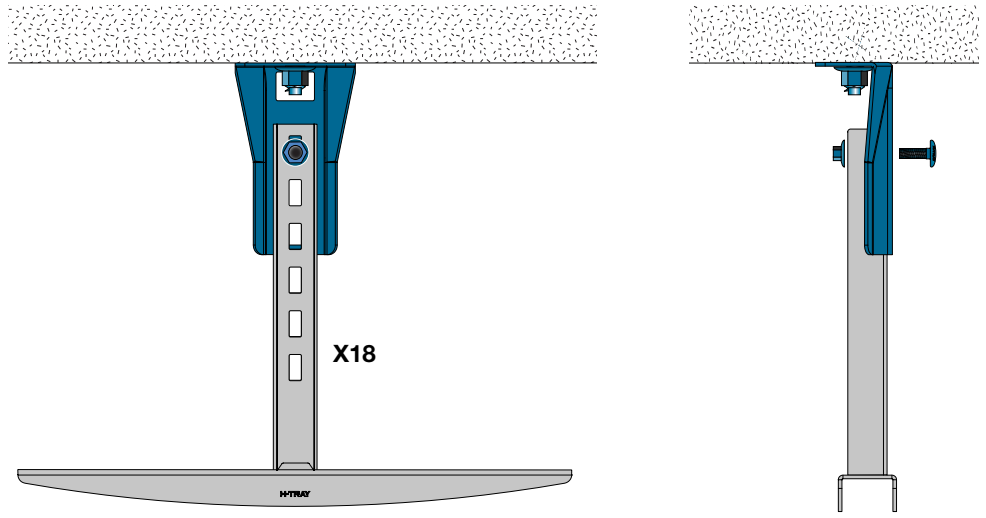
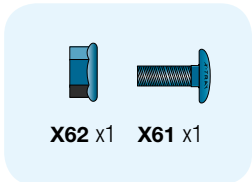
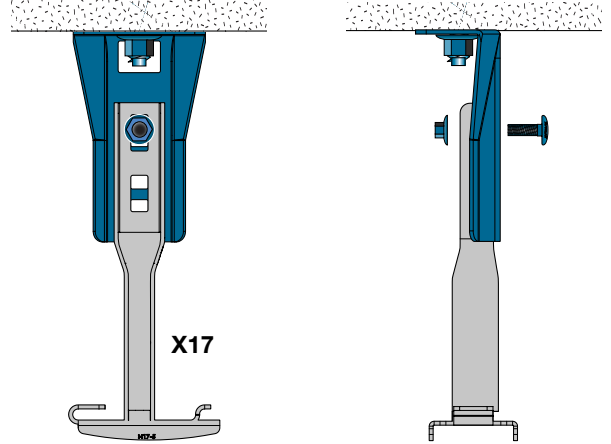
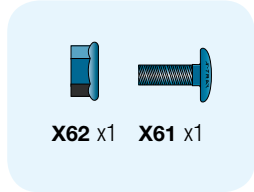
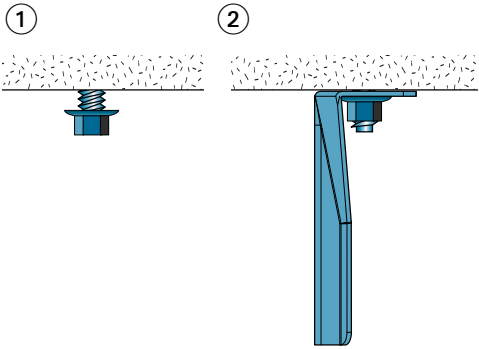

# X14 MOUNTING



53-75

**X1 x1**

**X62 x1 X61 x1**

**X1**

53-75

**X1 x1 X62 x1 X61 x1**

**X1**

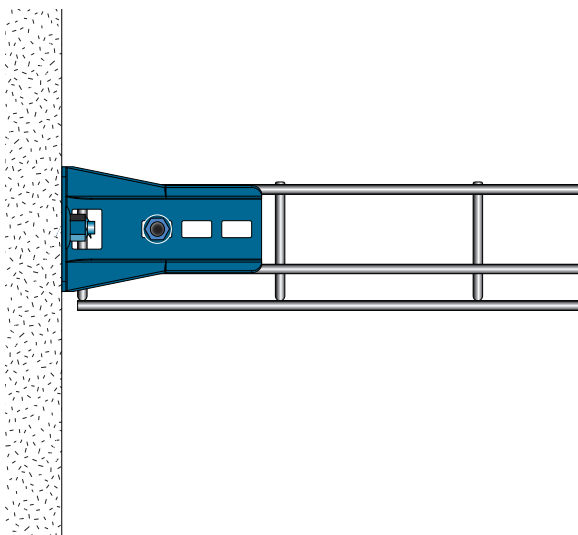

**X1**

**X1 x2 X62 x2 X61 x2**

**X1 x2 X62 x2 X61 x2**

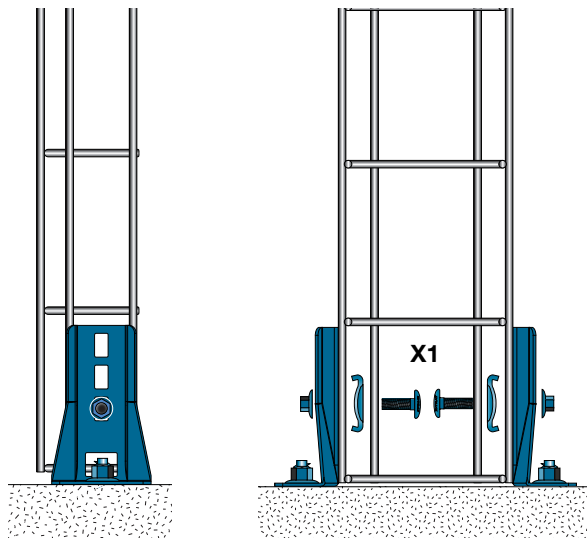

**X1 x6 X62 x6 X61 x6**

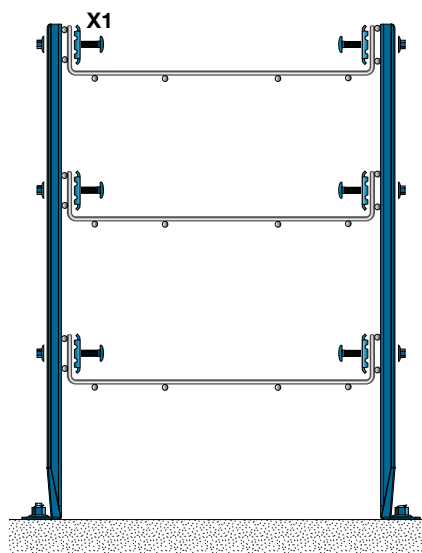

Installation





# X17 MOUNTING

120-320

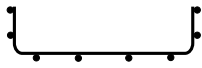

X62 x1



X61 x1

①

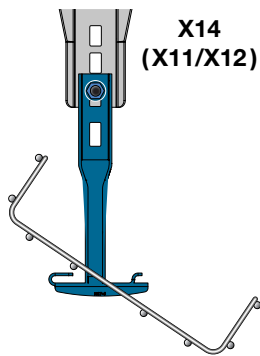

②

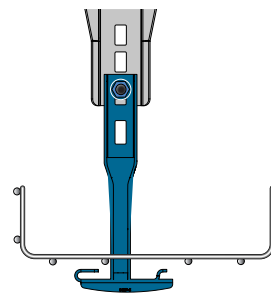

③

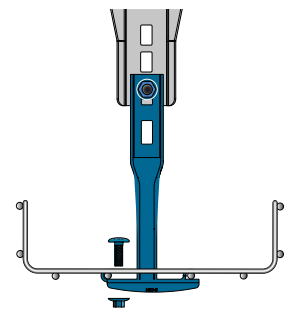

# X18 MOUNTING

420-620



X1 x2



X62 x2



X61 x2

①

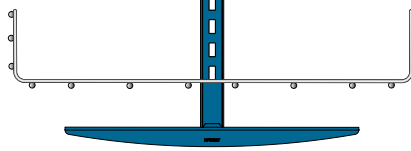

②

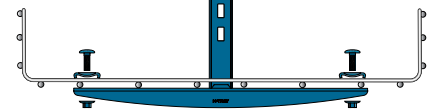

# X11/240-480 MOUNTING



X62 x2



X61 x2

X18

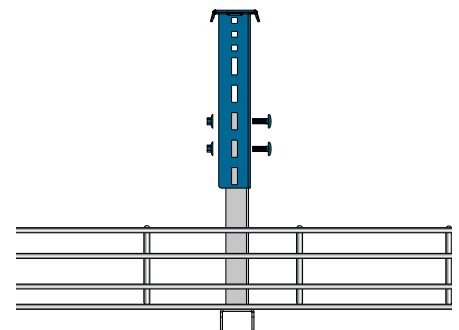
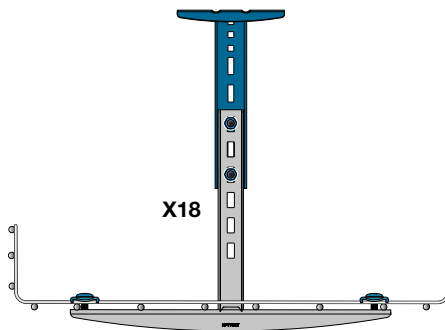

X62 x2



X61 x2

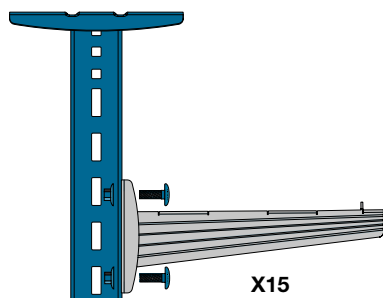

X15

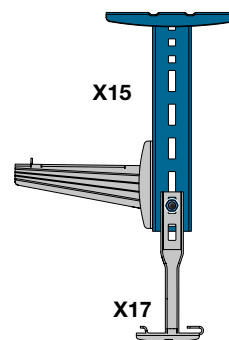

X15

X17

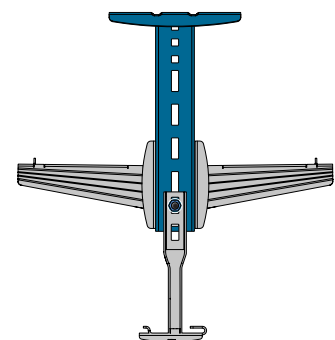

# X11/240-480 MOUNTING

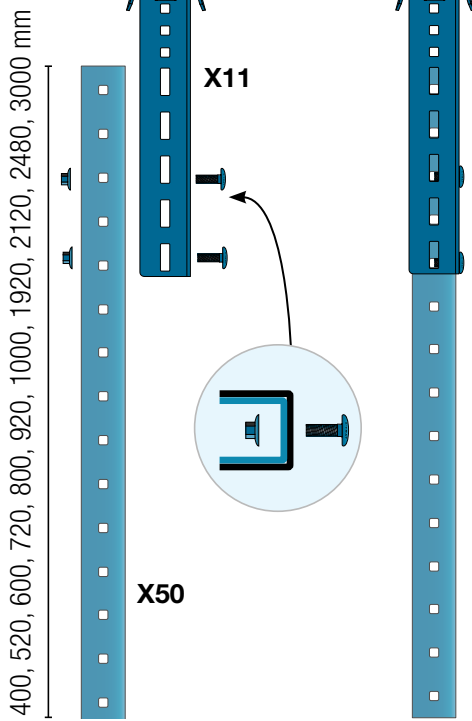
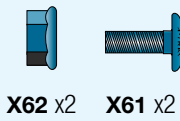

420-620

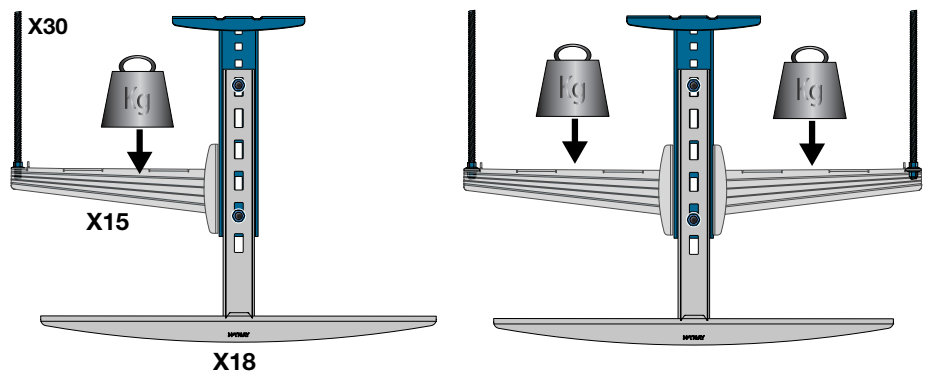
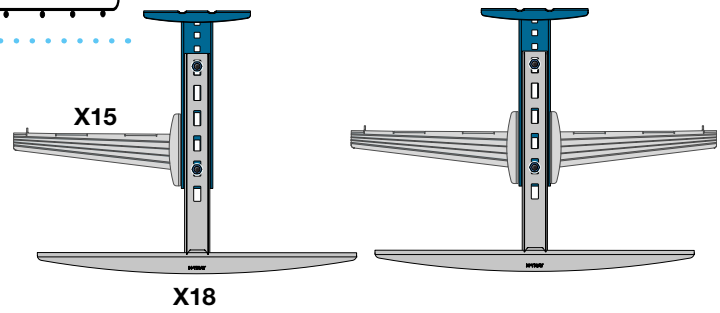
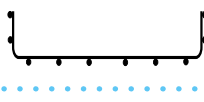

# X50 MOUNTING



120-320

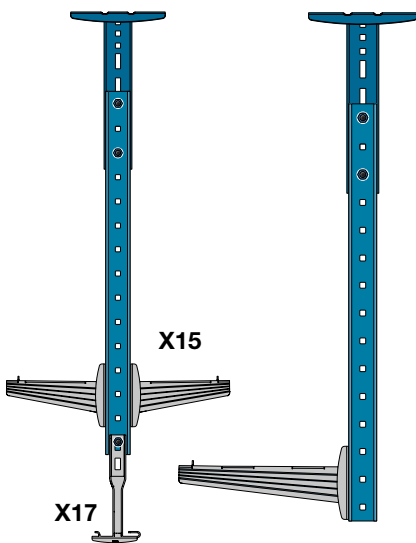
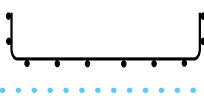

420-620

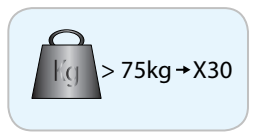
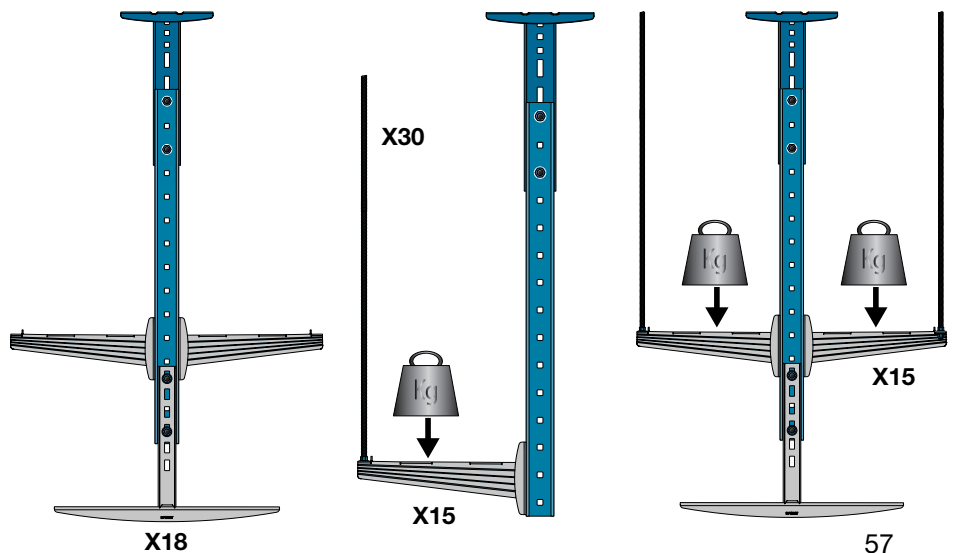
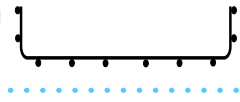

Installation



# X51 MOUNTING

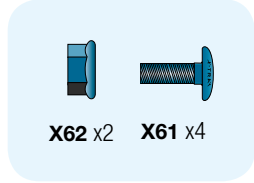
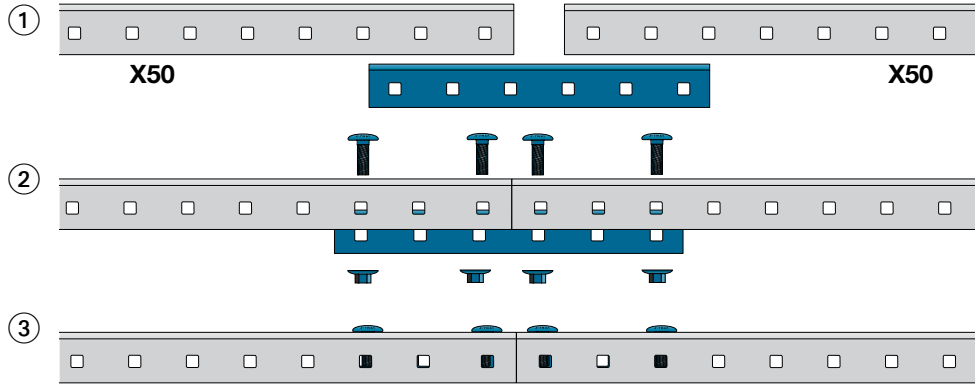
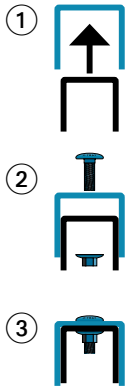

X62 x2 X61 x4



# X52 MOUNTING

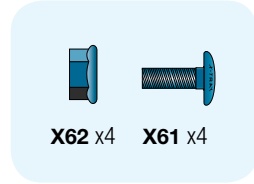
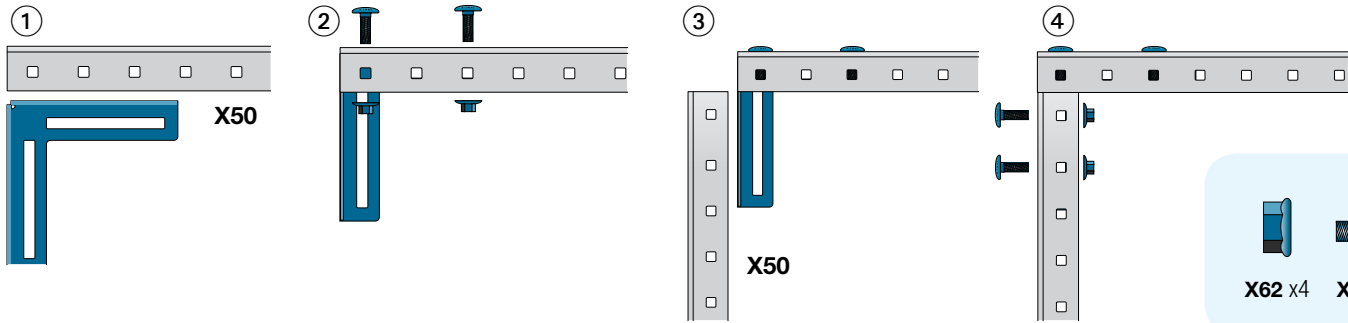

X62 x4 X61 x4

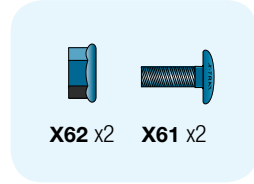
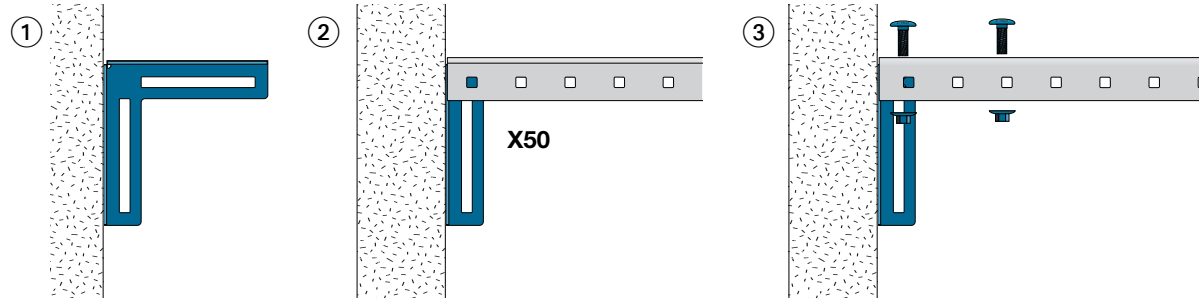

X62 x2 X61 x2

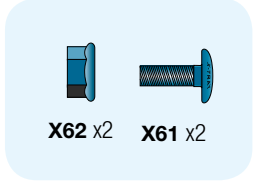
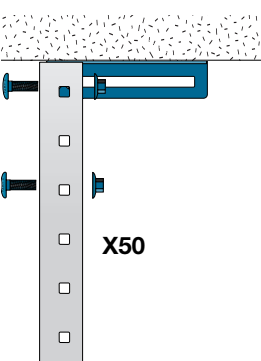

58

X62 x2 X61 x2

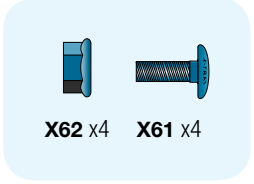
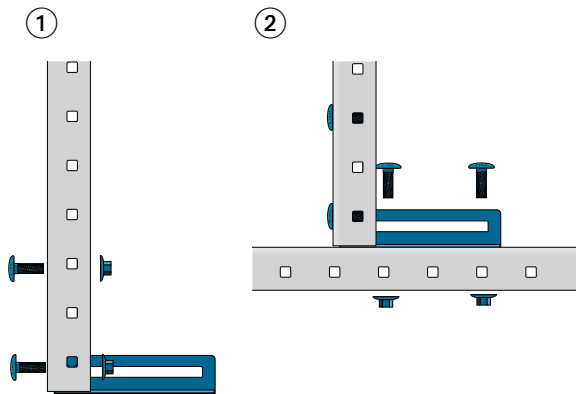

X62 x4 X61 x4

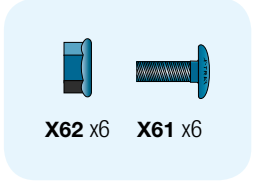
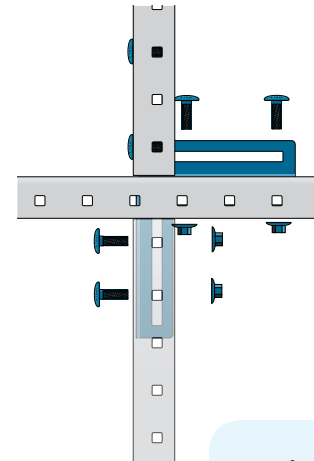

X62 x6 X61 x6

# X52 MOUNTING

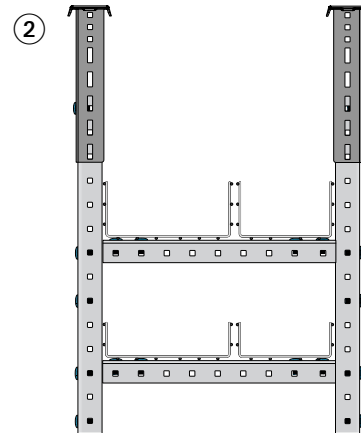
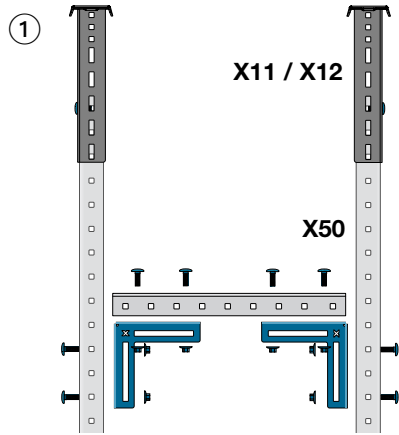
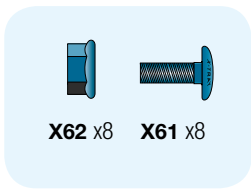

# X53 MOUNTING

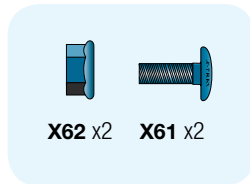
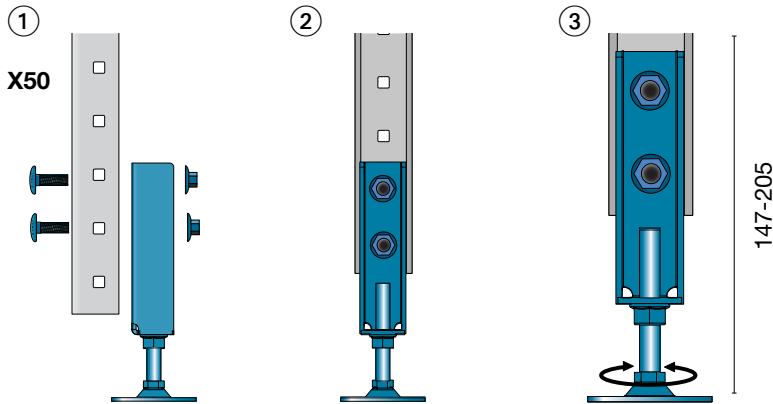

# X55 MOUNTING

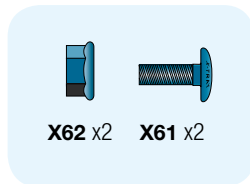
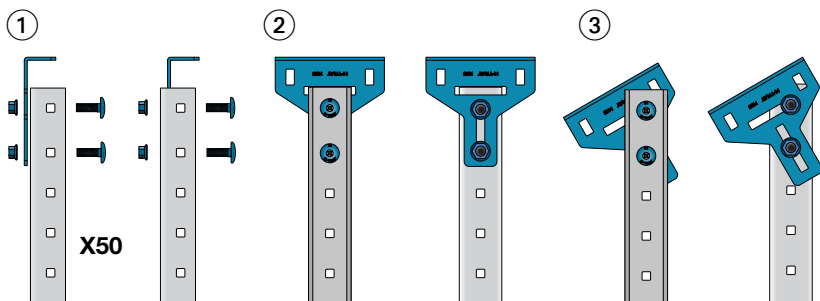

# X13 MOUNTING

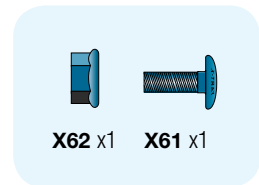
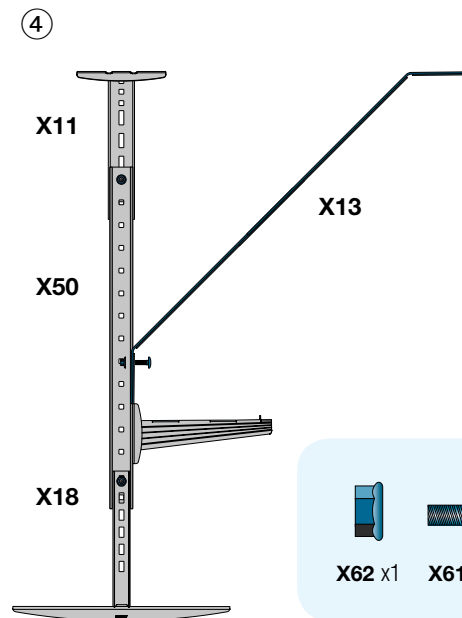
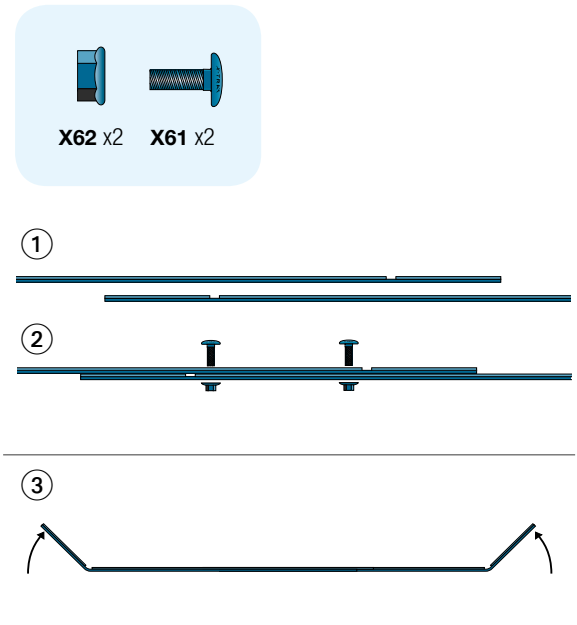

Installation



# X12 MOUNTING

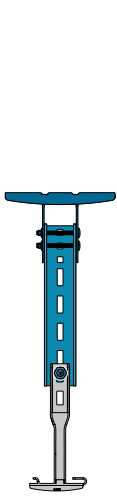
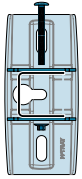
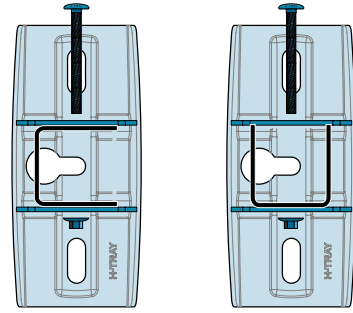
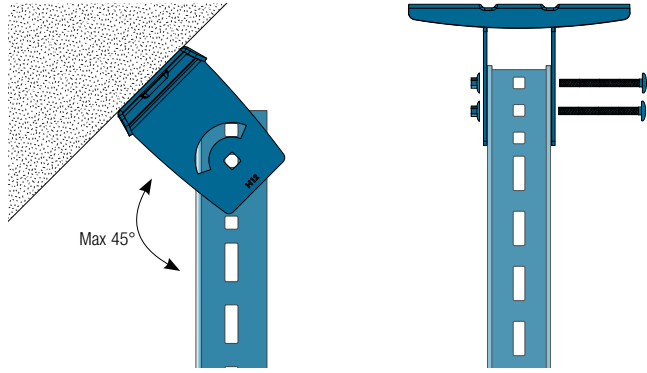

X17

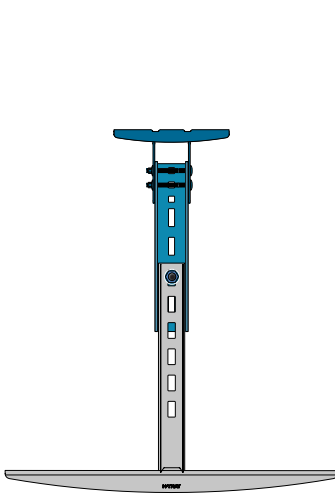

X18

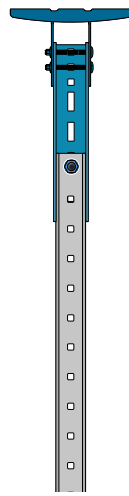

X50

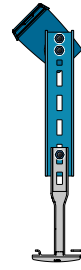
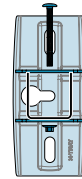

X17

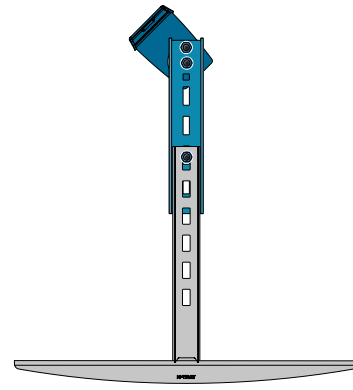

X18

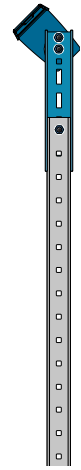

X50

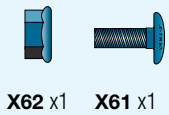

X62 x1 X61 x1

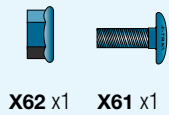

X62 x1 X61 x1

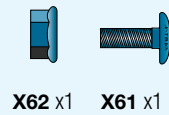

X62 x1 X61 x1

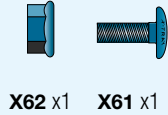

X62 x1 X61 x1

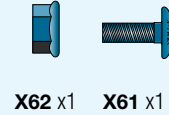

X62 x1 X61 x1

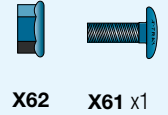

X62 X61 x1



# X16 MOUNTING

53-320



X1 x2

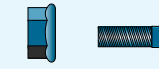

X62 x4 X61 x4

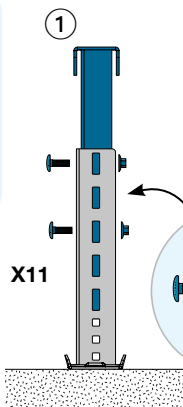

①

X11

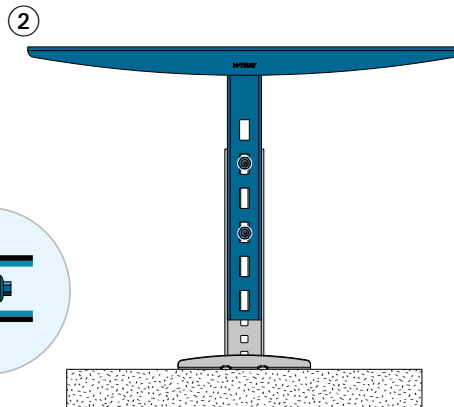

②

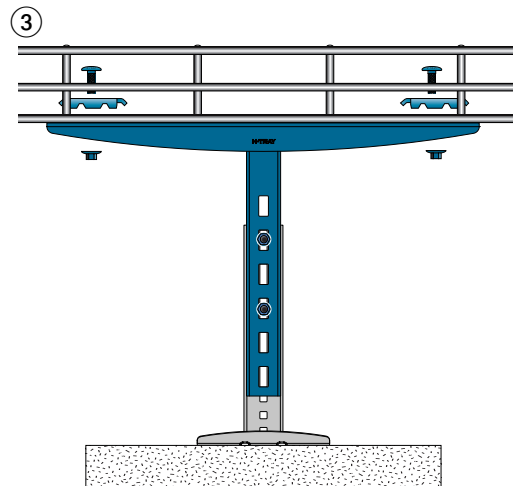

③

# X16 MOUNTING



420-620

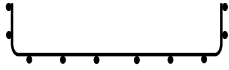

X1 x2



X62 x4 X61 x4

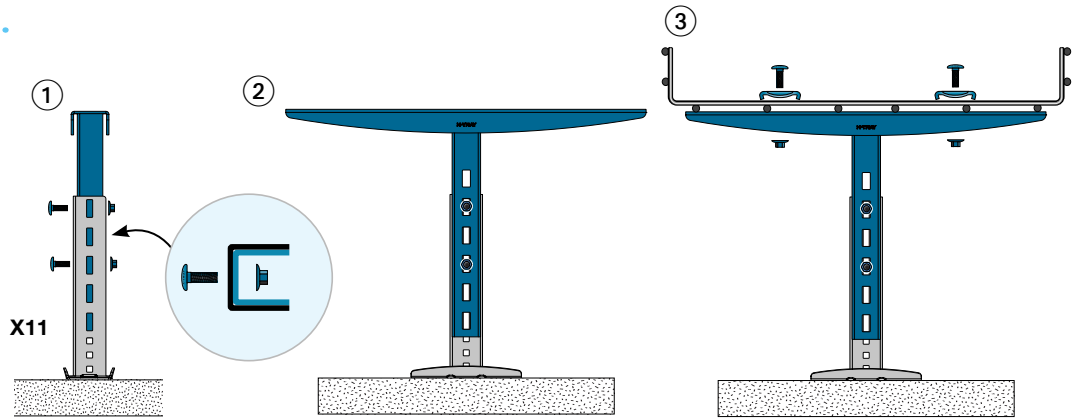

## X31 MOUNTING



120-220



X62 x3 X61 x1

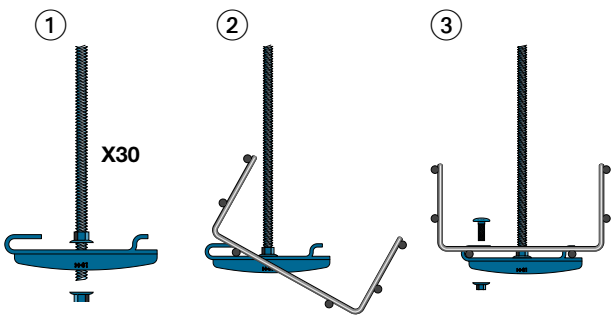

## X33 & X30 MOUNTING

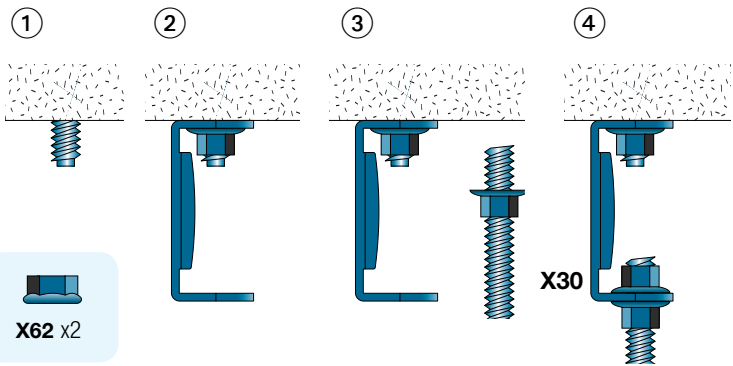

60-75



X1 x1  
X62 x2 X4 x1

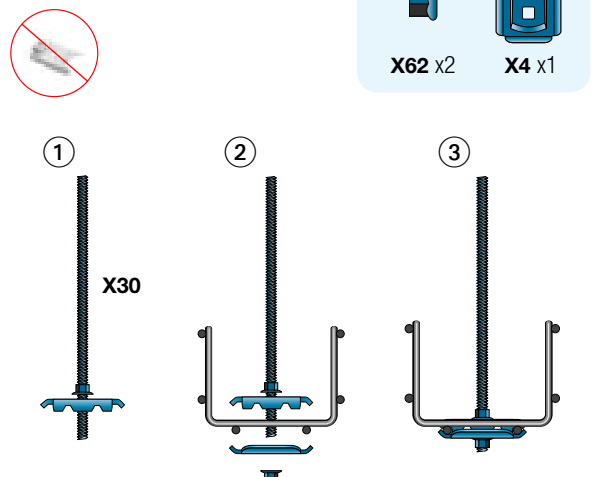

53-320



X62 x2

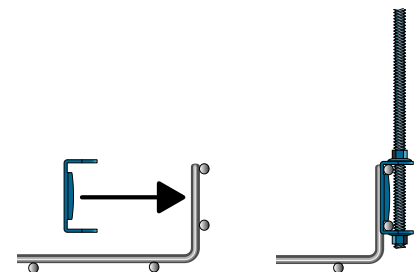

420-620



X1 x2 X62 x6 X61 x2

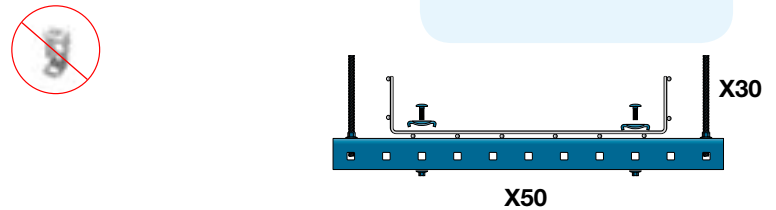

Installation



# X34 MOUNTING

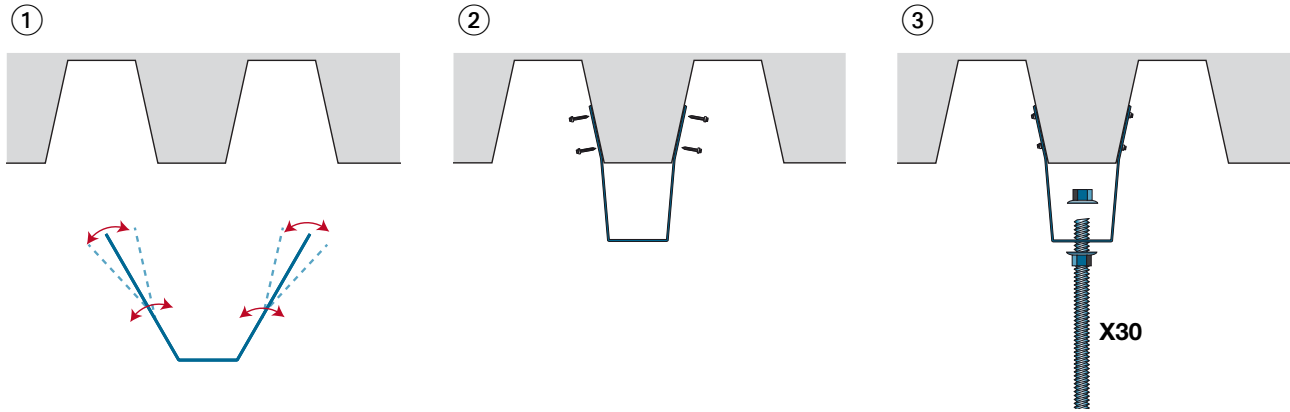

# X30 & X36 MOUNTING

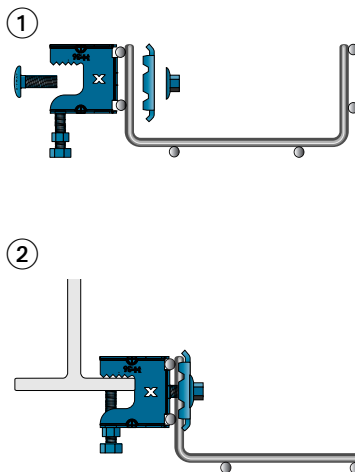
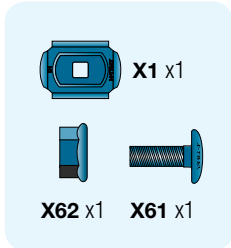
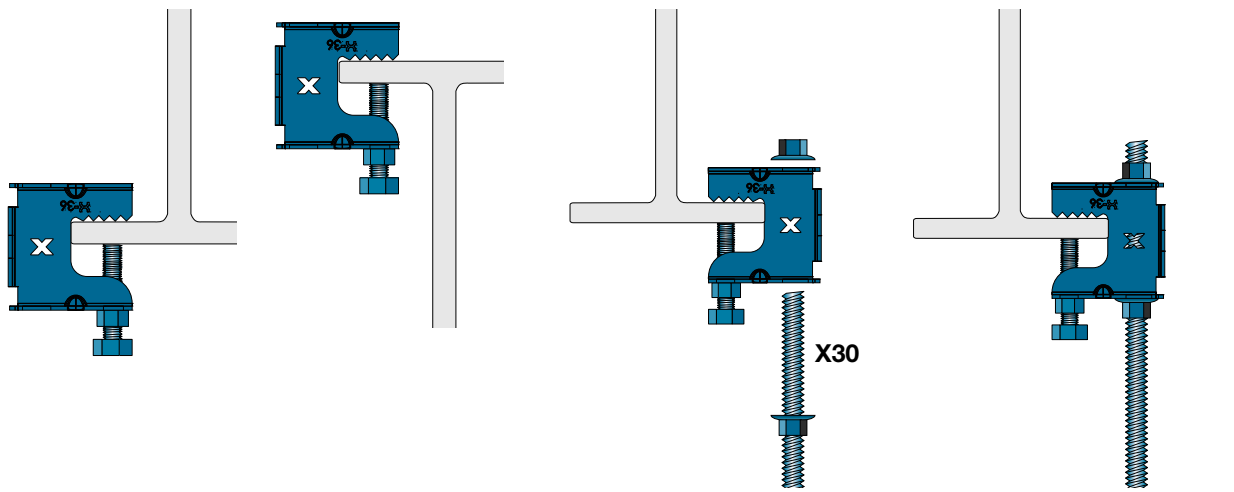

# X30 & X35 MOUNTING

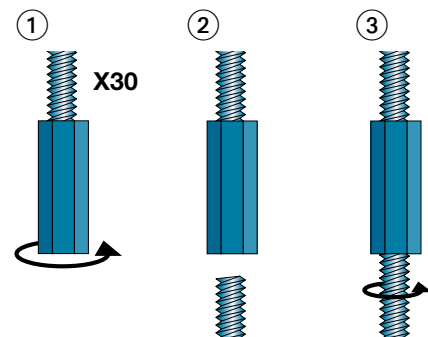

# X70 & X72 MOUNTING

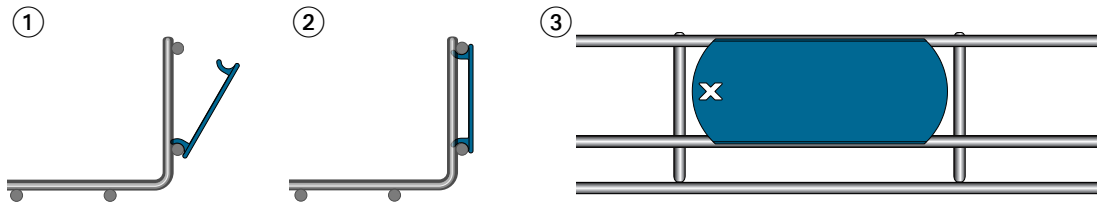

# X63 MOUNTING

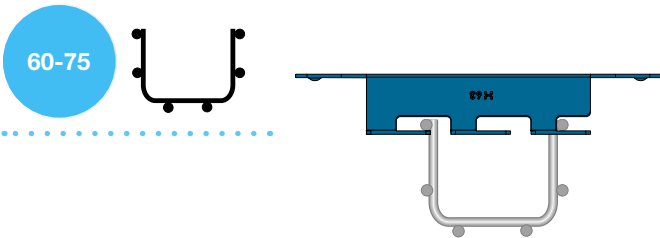
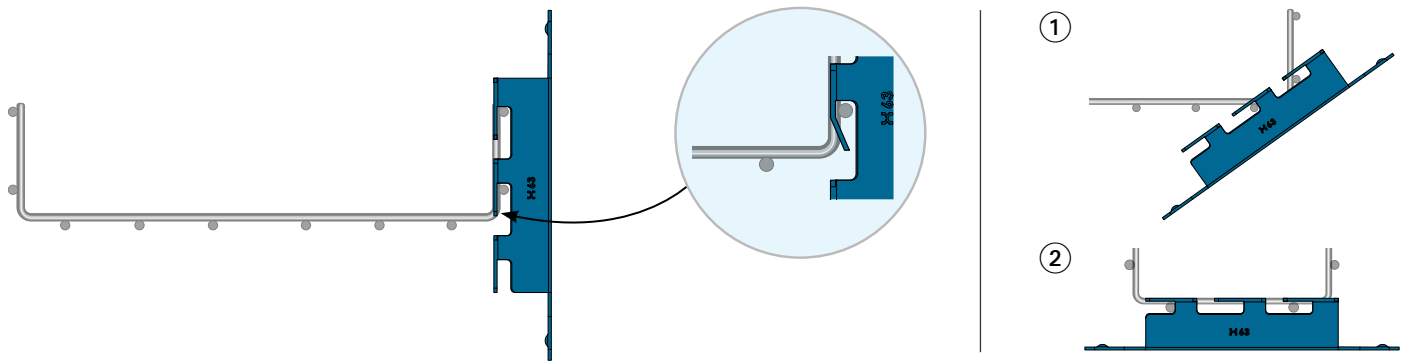

# X80 MOUNTING

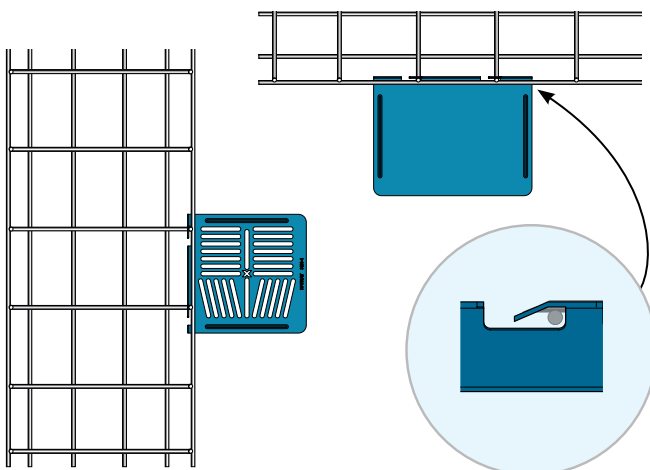

# X81 MOUNTING

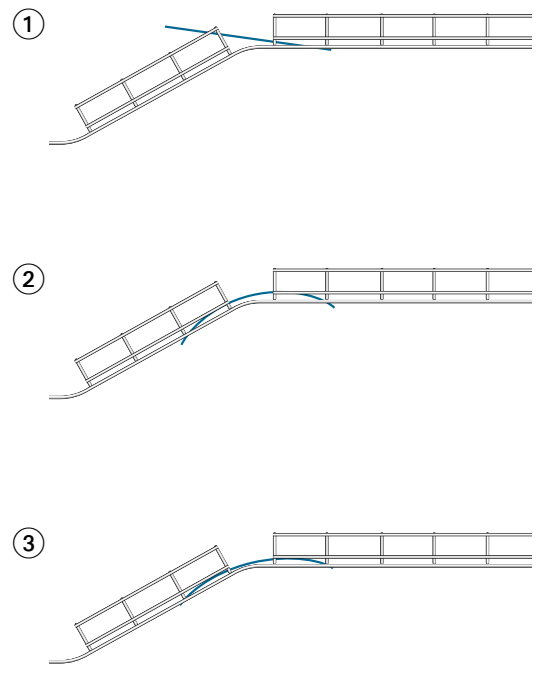
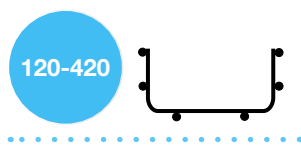

Installation





# X60 MOUNTING

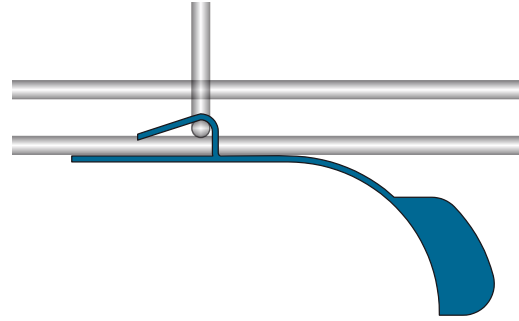
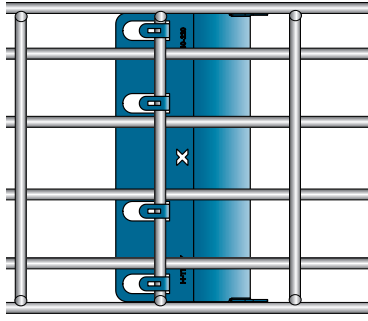

120-420

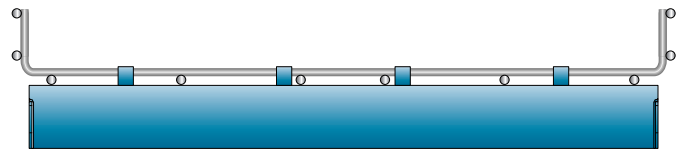
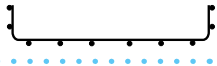

X60 120-420

520

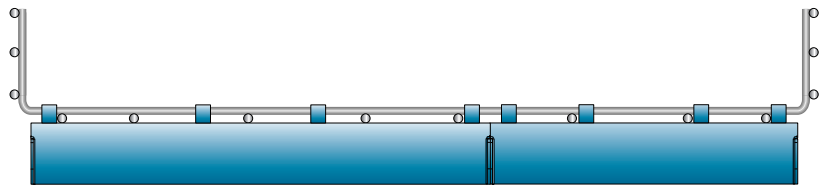
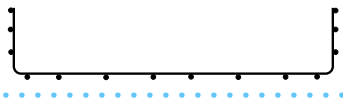

X60 320

X60 220

620

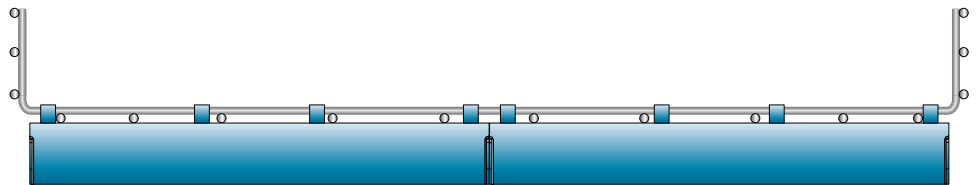
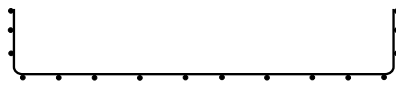

X60 320

X60 320

120-620

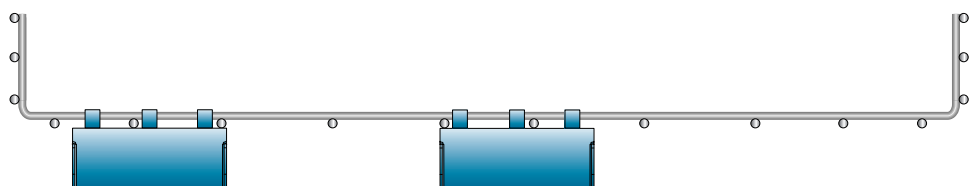

X60 120

X60 120

# X65 MOUNTING



53-620

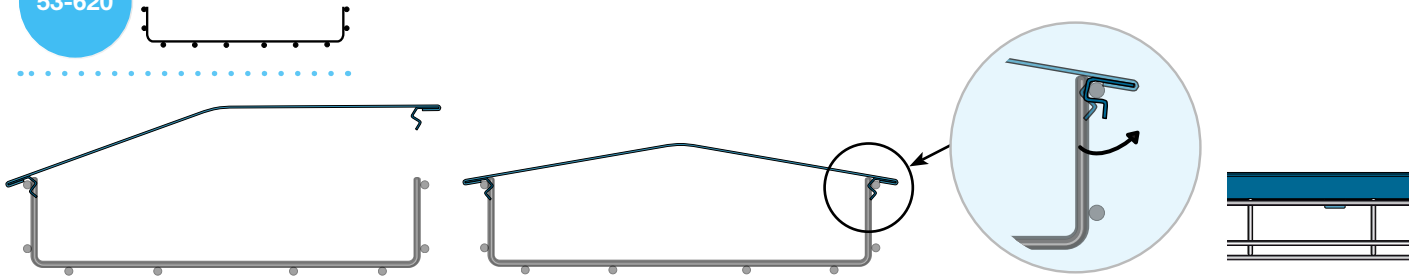

# X68 MOUNTING



2568

2568-1

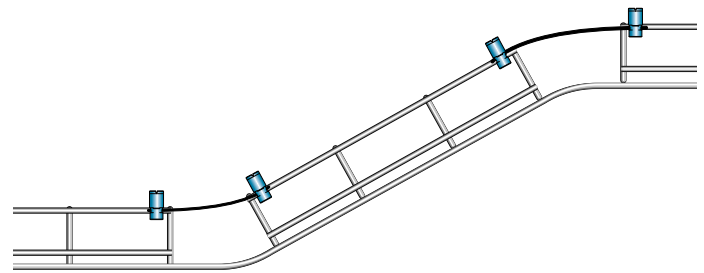
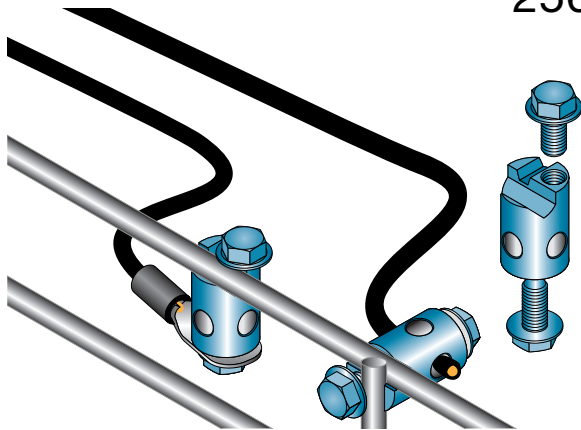

For more information on equipotential bonding, see page 67 or visit [axelent.com](http://axelent.com)

# X69 MOUNTING

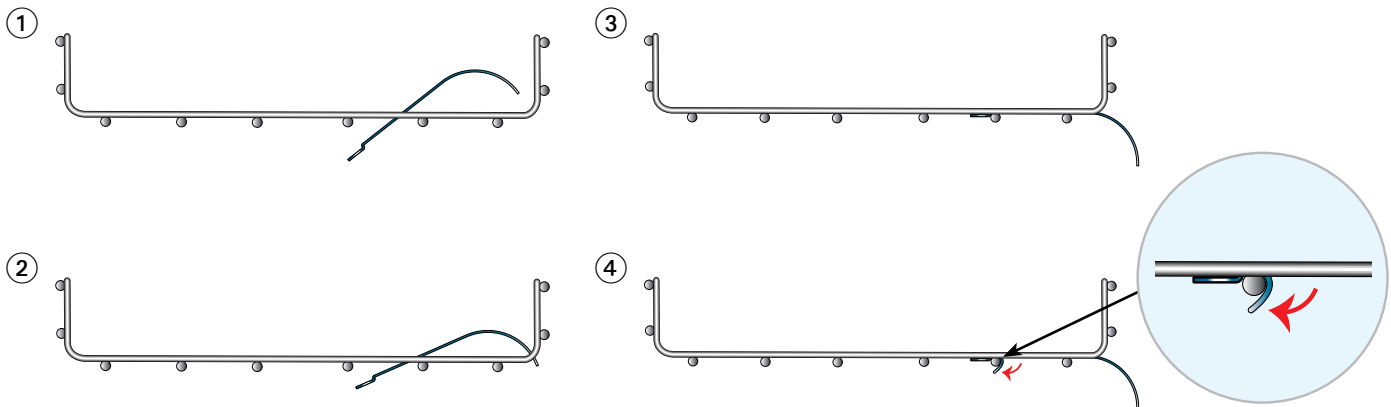

Installation



## X64 MOUNTING

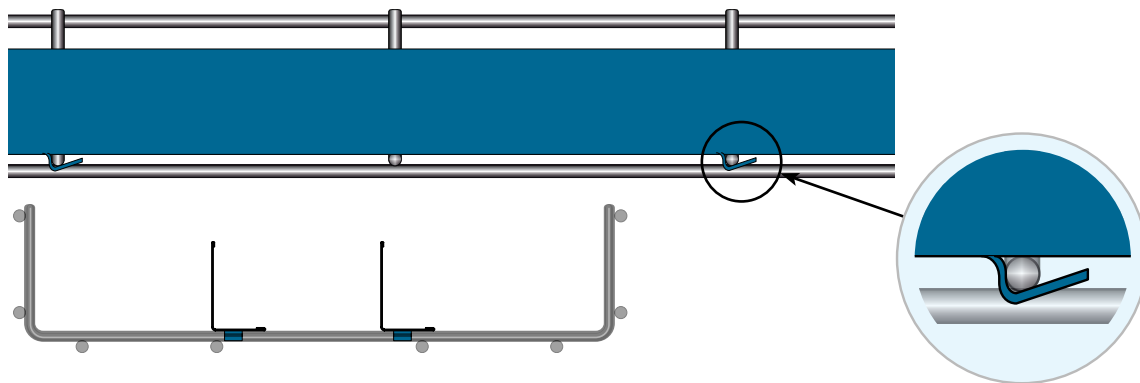

## X69 & X67 MOUNTING

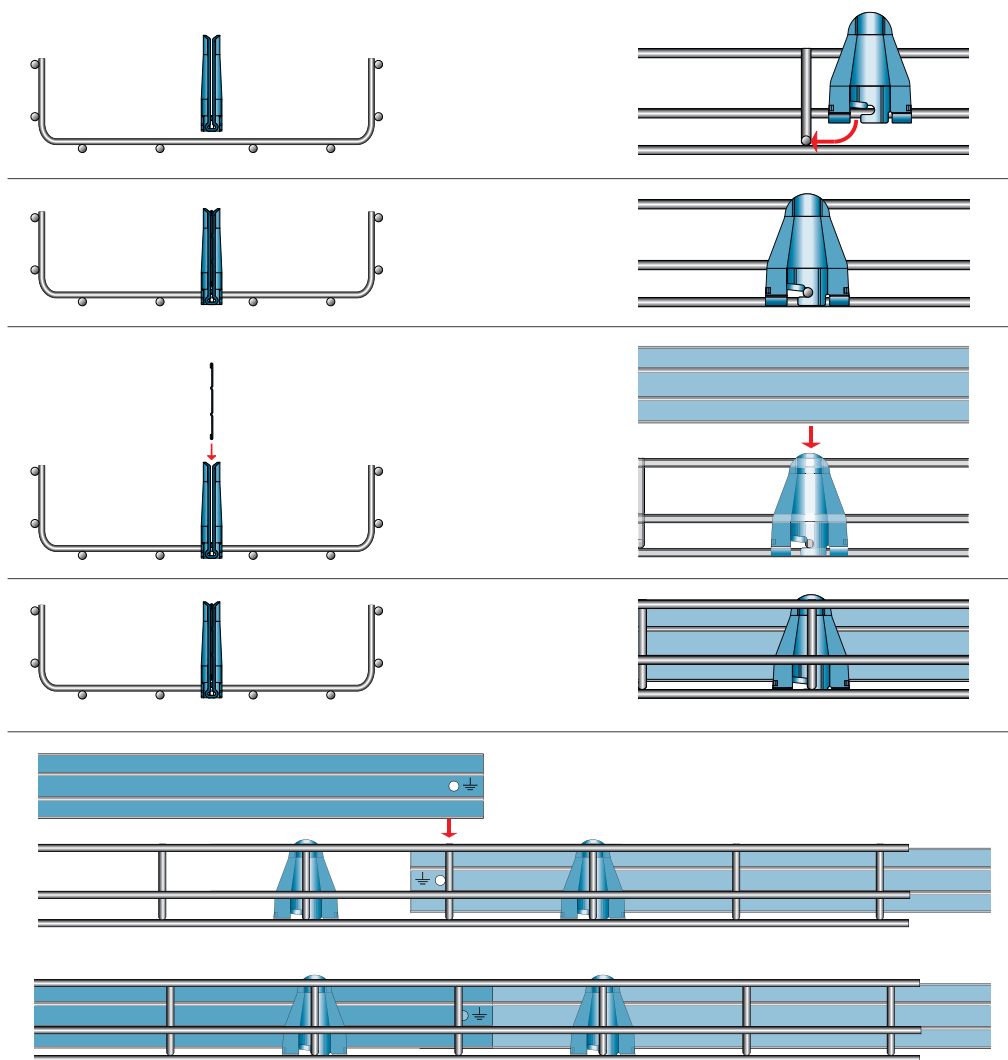

# X-Tray Equipotential Bonding

- ✓ X-Tray is tested in compliance with IEC61537 and fulfills the low impedance requirements in trays and joints. Impedance must not exceed 50 mΩ/ on joints and 5 mΩ/m on trays. As Axelent's X-Tray Cable Tray range is specially Materialled for this purpose, its accessories must always be used. The functionality of other brands cannot be guaranteed. To fulfill the conductivity demands in the following installation, a copper cable must be used that is correctly dimensioned and installed according to the instructions.

- ✓ An end cap on the cable is recommended if there is a risk of corrosion.
- ✓ Cable trays do not normally need functional or protective bonding as they are not external conducting components because they are part of the electrical installation. In addition, they are not normally accessible and are not pulled into the building but are installed inside the building.

## Functional equipotential bonding

- ✓ Functional bonding is used when there is a risk of interference due to equipotential differences to cable trays, and to secure the correct function of electrical equipment. (EMC) Earthing shielding is permitted, that is to say, the cable trays may be used as functional bonding conductors.
- ✓ A functional bonding conductor must not be marked with the colour combinations green and yellow.
- ✓ X-Tray wire trays are approved for functional bonding without the need of a parallel separate cable, on condition that installation is carried out in accordance with the instructions in this manual. If the joinings are broken, so is the equipotential bonding.

## Protective equipotential bonding

- ✓ Protective bonding is done for safety's sake to protect against electric shocks from touch voltage.
- ✓ The protective bonding of cable trays is seldom required. In principle, only if the cable is buried in the ground and enters the building from the outside. When used, the conductor must be marked in the colour combination of green and yellow.
- ✓ X-Tray cable trays must never be used as protective bonding conductors, earth conductors or any other type of protective conductor.

Name	Finish	Item No.	E-number	Max cable area	Installing copper cable
X68 Equipotential Bonding Screw	Brass, nickel-plated	2568	1133370	25 mm <sup>2</sup>	
X68 Equipotential Earth Screw	Brass, nickel-plated	2568-1	1133371	25 mm <sup>2</sup>	
X70 Marking Clip Equip. Bonding	Plastic, white, Swe	2570-02	1133373		
X70 Marking Clip Equip. Bonding	Plastic, white, Eng	2570-03	1133374		
X70 Marking Clip Equip. Bonding	Plastic, white, German	2570-04	1133375		

The following installations are only approved in combination with copper cable.

Electro-galvanized and hot-dip galvanized	Stainless/Acid-proof	Always copper cable: X-Tray 53, 60, 75, 100, 120, 150, (220x30)
<p>X-Tray 53, 60, 75</p>	<p>X-Tray 150, 220</p>	<p>X-Tray 150, 220, 320</p>
	<p>X-Tray 150, 220, 320, 420, 520, 620</p>	

# Axelent X-Tray

Axelent develops, manufactures and markets a cable routing system based on wire trays with fittings, brackets and accessories under the X-Tray brand.

In cooperation with our distributors and end users, we work to create the most qualified, costeffective and functional solutions possible.

We offer a wide basic range of products that satisfy the requirements of most industries, but we also offer applications for unique requirements. We can offer a complete solution that encompasses everything from drawings to the complete product that is delivered on site. All of our standard products are in stock, which allows for quick delivery.



AXELLENT AB · BOX 1 · KÄVSJÖVÄGEN 17 · 335 04 HILLERSTORP, SWEDEN  
0370-37 37 37 · TEAMXTRAY@AXELLENT.SE · WWW.AXELLENT.SE



GB1910\_1.0\_ENSU